



REFRIGERANT REFERENCE GUIDE

**WORLDWIDE REFRIGERANT SUPPLIER
2004 FOURTH EDITION 2004**

DISCLAIMER

This publication is designed to provide accurate and authoritative information. It is not to be construed as the rendering of any professional advice, counsel or services. The information contained herein is based on technical data and tests provided and/or conducted by others believed to be reliable and is intended for use by persons having the necessary technical skill and equipment, at their own discretion and risk.

National Refrigerants' programs and publications are designed solely to help customers maintain their professional competence. In dealing with specific technical matters, customers using National Refrigerants' publications or orally conveyed information should also refer to the original sources of authority. **THE MANUFACTURER'S RECOMMENDATIONS SHOULD ALWAYS BE FOLLOWED TO ASSURE OPTIMUM PERFORMANCE AND SAFETY.**

Since conditions of use are outside of National Refrigerant's control, we can assume no liability for results obtained or any damages incurred through the use or application of the data presented. The language contained herein is not contractual in nature. By a separate document, National Refrigerants, Inc. will enter into a written contract with interested parties, which contract will be specifically limited to its own terms and conditions.

National Refrigerants, Inc.

Refrigerant Reference Guide Fourth Edition
(4.01)

Copyright© 2004 by NRI™

Table of Contents

Section 1 – Refrigerants – Technical Guidelines	Page
• Part Numbers	5 – 8
• Refrigerant Property Summary	9
• Application Summary	10
• Product Data Summary and Thermodynamic Tables	
R-11 and R-12	11 - 13
R-13	14 - 15
R-22	16 - 17
R-23	18 - 19
R-123 and R-124	20 - 22
R-134a	23 - 24
R-401A and R-401B	25 - 27
R-402A and R-402B	28 - 30
R-403B	31 - 32
R-404A	33 - 34
R-407C	35 - 36
R-408A	37 - 38
R-409A	39 - 40
R-410A	41 - 42
R-414B	43 - 44
R-416A	45 - 46
R-417A	47 - 48
R-500 and R-502	49 - 51
R-503	52 - 53
R-507	54 - 55
R-508B	56 - 57
• ARI Chemical Names and Color Codes	58
Section 2 – Retrofits and Conversions	59
• Blend Behavior and Technical Issues	60 - 83
• Retrofit Checklist and System Data Sheet	84 - 85
• General Retrofit Guidelines and Procedures	86 - 92

I. Refrigerants: Technical Data

- NRI Part Numbers 5 - 8
- Properties Summary Table 9 - 10
- Thermodynamic Data 11 - 57
- ARI Cylinder Color Codes 58

REFRIGERANTS

PART NO.	DESCRIPTION
100R11	100 LB. DRUM OF REFRIGERANT 11
200R11	200 LB. DRUM OF REFRIGERANT 11
650R11	650 LB. DRUM OF REFRIGERANT 11
1100R11	1100 LB. CYLINDER OF REFRIGERANT 11 RETURNABLE/DEPOSIT
2200R11	2200 LB. CYLINDER OF REFRIGERANT 11 RETURNABLE/DEPOSIT
012R12	12 OZ CAN OF REFRIGERANT 12
30R12	30 LB. CYLINDER OF REFRIGERANT 12
30R12RT	30 LB. CYLINDER OF REFRIGERANT 12 RETURNABLE/DEPOSIT
50R12	50 LB. CYLINDER OF REFRIGERANT 12
145RR12	30 LB. CYLINDER OF REFRIGERANT 12 RETURNABLE/DEPOSIT
1000R12	30 LB. CYLINDER OF REFRIGERANT 12 RETURNABLE/DEPOSIT
2000R12	30 LB. CYLINDER OF REFRIGERANT 12 RETURNABLE/DEPOSIT
5R13	5 LB. CYLINDER OF REFRIGERANT 13
9R13	9 LB. CYLINDER OF REFRIGERANT 13 RETURNABLE/DEPOSIT
23R13	23 LB. CYLINDER OF REFRIGERANT 13 RETURNABLE/DEPOSIT
80R13	80 LB. CYLINDER OF REFRIGERANT 13 RETURNABLE/DEPOSIT
5R13B1	5 LB. CYLINDER OF REFRIGERANT 13B1
10R13B1	10 LB. CYLINDER OF REFRIGERANT 13B1 RETURNABLE/DEPOSIT
28R13B1	28 LB. CYLINDER OF REFRIGERANT 13B1 RETURNABLE/DEPOSIT
90R13B1	90 LB. CYLINDER OF REFRIGERANT 13B1 RETURNABLE/DEPOSIT
15R22	15 LB. CYLINDER OF REFRIGERANT 22
30R22	30 LB. CYLINDER OF REFRIGERANT 22
30R22RT	30 LB. CYLINDER OF REFRIGERANT 22 RETURNABLE/DEPOSIT
50R22	50 LB. CYLINDER OF REFRIGERANT 22
125R22	125 LB. CYLINDER OF REFRIGERANT 22 RETURNABLE/DEPOSIT
1000R22	1000 LB. CYLINDER OF REFRIGERANT 22 RETURNABLE/DEPOSIT
1750R22	1750 LB. CYLINDER OF REFRIGERANT 22 RETURNABLE/DEPOSIT
5R23	5 LB. CYLINDER OF REFRIGERANT 23
9R23	9 LB. CYLINDER OF REFRIGERANT 23 RETURNABLE/DEPOSIT
20R23	20 LB. CYLINDER OF REFRIGERANT 23 RETURNABLE/DEPOSIT
70R23	70 LB. CYLINDER OF REFRIGERANT 23 RETURNABLE/DEPOSIT
100R113	100 LB. DRUM OF REFRIGERANT 113
200R113	100 LB. DRUM OF REFRIGERANT 113
690R113	100 LB. DRUM OF REFRIGERANT 113
30R114	30 LB. CYLINDER OF REFRIGERANT 114
150R114	150 LB. CYLINDER OF REFRIGERANT 114 RETURNABLE/DEPOSIT
90R116	90 LB. CYLINDER OF REFRIGERANT 116 RETURNABLE/DEPOSIT
100CR123	100 LB. CYLINDER OF REFRIGERANT 123 RETURNABLE/DEPOSIT
200CR123	200 LB. CYLINDER OF REFRIGERANT 123 RETURNABLE/DEPOSIT
100R123	100 LB. DRUM OF REFRIGERANT 123
200R123	200 LB. DRUM OF REFRIGERANT 123
650R123	650 LB. DRUM OF REFRIGERANT 123

REFRIGERANTS

PART NO.	DESCRIPTION
30R124	30 LB. CYLINDER OF REFRIGERANT 124
30R124RT	30 LB. CYLINDER OF REFRIGERANT 124 RETURNABLE/DEPOSIT
125R124	125 LB. CYLINDER OF REFRIGERANT 124 RETURNABLE/DEPOSIT
2000R124	2000 LB. CYLINDER OF REFRIGERANT 124 RETURNABLE/DEPOSIT
012R134a	12 OZ CAN OF REFRIGERANT 134a
30R134a	30 LB. CYLINDER OF REFRIGERANT 134a
30R134aRT	30 LB. CYLINDER OF REFRIGERANT 134a RETURNABLE/DEPOSIT
A30R134a	30 LB. CYLINDER OF REFRIGERANT 134a AUTOMOTIVE VALVE
125R134a	125 LB. CYLINDER OF REFRIGERANT 134a RETURNABLE/DEPOSIT
875R134a	850 LB. CYLINDER OF REFRIGERANT 134a RETURNABLE/DEPOSIT
1750R134a	1750 LB. CYLINDER OF REFRIGERANT 134a RETURNABLE/DEPOSIT
30R401A	30 LB. CYLINDER OF REFRIGERANT 401A
125R401A	125 LB. CYLINDER OF REFRIGERANT 401A RETURNABLE/DEPOSIT
1700R401A	1700 LB. CYLINDER OF REFRIGERANT 401A RETURNABLE/DEPOSIT
27R402A	30 LB. CYLINDER OF REFRIGERANT 402A
110R402A	150 LB. CYLINDER OF REFRIGERANT 402A RETURNABLE/DEPOSIT
13R402B	30 LB. CYLINDER OF REFRIGERANT 402B
30R403B	30 LB. CYLINDER OF REFRIGERANT 403B
100R403B	100 LB. CYLINDER OF REFRIGERANT 403B RETURNABLE/DEPOSIT
875R403B	875 LB. CYLINDER OF REFRIGERANT 403B RETURNABLE/DEPOSIT
1750R403B	1750 LB. CYLINDER OF REFRIGERANT 403B RETURNABLE/DEPOSIT
24R404A	24 LB. CYLINDER OF REFRIGERANT 404A
100R404A	100 LB. CYLINDER OF REFRIGERANT 404A RETURNABLE/DEPOSIT
1300R404A	1300 LB. CYLINDER OF REFRIGERANT 404A RETURNABLE/DEPOSIT
25R407C	25 LB. CYLINDER OF REFRIGERANT 407C
115R407C	115 LB. CYLINDER OF REFRIGERANT 407C RETURNABLE/DEPOSIT
24R408A	24 LB. CYLINDER OF REFRIGERANT 408A
1000R408A	1000 LB. CYLINDER OF REFRIGERANT 408A RETURNABLE/DEPOSIT
30R409A	30 LB. CYLINDER OF REFRIGERANT 409A
125R409A	125 LB. CYLINDER OF REFRIGERANT 409A RETURNABLE/DEPOSIT
25R410A	25 LB. CYLINDER OF REFRIGERANT 410A
100R410A	100 LB. CYLINDER OF REFRIGERANT 410A RETURNABLE/DEPOSIT
1450R410A	1450 LB. CYLINDER OF REFRIGERANT 410A RETURNABLE/DEPOSIT
25R414B	25 LB. CYLINDER OF REFRIGERANT 414B
30R416A	30 LB. CYLINDER OF REFRIGERANT 416A
125R416A	125 LB. CYLINDER OF REFRIGERANT 416A RETURNABLE/DEPOSIT
25R417A	25 LB. CYLINDER OF REFRIGERANT 417A
125R417A	125 LB. CYLINDER OF REFRIGERANT 417A RETURNABLE/DEPOSIT

REFRIGERANTS

PART NO.	DESCRIPTION
30R500	30 LB. CYLINDER OF REFRIGERANT 500
50R500	50 LB. CYLINDER OF REFRIGERANT 500
125R500	125 LB. CYLINDER OF REFRIGERANT 500 RETURNABLE/DEPOSIT
875R500	825 LB. CYLINDER OF REFRIGERANT 500 RETURNABLE/DEPOSIT
1750R500	1750 LB. CYLINDER OF REFRIGERANT 500 RETURNABLE/DEPOSIT
30R502	30 LB. CYLINDER OF REFRIGERANT 502
30R502RT	30 LB. CYLINDER OF REFRIGERANT 502 RETURNABLE/DEPOSIT
50R502	50 LB. CYLINDER OF REFRIGERANT 502
125R502	125 LB. CYLINDER OF REFRIGERANT 502 RETURNABLE/DEPOSIT
875R502	825 LB. CYLINDER OF REFRIGERANT 502 RETURNABLE/DEPOSIT
1750R502	1750 LB. CYLINDER OF REFRIGERANT 502 RETURNABLE/DEPOSIT
5R503	5 LB. CYLINDER OF REFRIGERANT 503
9R503	9 LB. CYLINDER OF REFRIGERANT 503 RETURNABLE/DEPOSIT
20R503	20 LB. CYLINDER OF REFRIGERANT 503 RETURNABLE/DEPOSIT
80R503	80 LB. CYLINDER OF REFRIGERANT 503 RETURNABLE/DEPOSIT
25R507	25 LB. CYLINDER OF REFRIGERANT 507
100R507	100 LB. CYLINDER OF REFRIGERANT 507 RETURNABLE/DEPOSIT
1400R507	1400 LB. CYLINDER OF REFRIGERANT 507 RETURNABLE/DEPOSIT
5R508B	5 LB. CYLINDER OF REFRIGERANT 508B
10R508B	10 LB. CYLINDER OF REFRIGERANT 508B RETURNABLE/DEPOSIT
20R508B	20 LB. CYLINDER OF REFRIGERANT 508B RETURNABLE/DEPOSIT
70R508B	70 LB. CYLINDER OF REFRIGERANT 508B RETURNABLE/DEPOSIT

RECOVERY CONTAINERS

PART NO.	DESCRIPTION
75RC30	30 LB. RECOVERY CYLINDER (\$75.00 DEPOSIT)
75RC40	40 LB. RECOVERY CYLINDER (\$75.00 DEPOSIT)
75RC50	50 LB. RECOVERY CYLINDER (\$75.00 DEPOSIT)
100RC50F	50 LB. RECOVERY CYLINDER W/FLOAT (\$100.00 DEPOSIT)
125RC125	1250 LB. RECOVERY CYLINDER (\$125.00 DEPOSIT)
RC1000	½ TON RECOVERY CYLINDER (\$1000.00 DEPOSIT)
RC2800	1 TON RECOVERY CYLINDER (\$2800.00 DEPOSIT)
130RC9	9 LB. HIGH PRESSURE RECOVERY CYLINDER (\$130.00 DEPOSIT)
150RC23	23 LB. HIGH PRESSURE RECOVERY CYLINDER (\$150.00 DEPOSIT)
200RC80	80 LB. HIGH PRESSURE RECOVERY CYLINDER (\$200.00 DEPOSIT)

ANALYTICAL TESTING

PART NO.	DESCRIPTION
NRIHP	HIGH PRESSURE LIQUID REFRIGERANT TEST KIT
NRILP	LOW PRESSURE LIQUID REFRIGERANT TEST KIT
NRINC	NON-CONDENSABLE VAPOR REFRIGERANT TEST KIT
NRIOA	OIL ANALYSIS TEST KIT
NRIHALON	HALON ANALYSIS TEST KIT

LUBRICANTS

PART NO.	DESCRIPTION
1501G	1 GALLON CONTAINER OF REFRIGERATION MINERAL OIL 150 SUS VISCOSITY
1505G	5 GALLON CONTAINER OF REFRIGERATION MINERAL OIL 150 SUS VISCOSITY
15055G	55 GALLON CONTAINER OF REFRIGERATION MINERAL OIL 150 SUS VISCOSITY
150AKB1G	1 GALLON CONTAINER OF ALKYL BENZENE OIL 150 SUS VISCOSITY
200AKB1G	1 GALLON CONTAINER OF ALKYL BENZENE OIL 200 SUS VISCOSITY
300AKB1G	1 GALLON CONTAINER OF ALKYL BENZENE OIL 300 SUS VISCOSITY
3001G	1 GALLON CONTAINER OF REFRIGERATION MINERAL OIL 300 SUS VISCOSITY
3005G	5 GALLON CONTAINER OF REFRIGERATION MINERAL OIL 300 SUS VISCOSITY
30055G	55 GALLON CONTAINER OF REFRIGERATION MINERAL OIL 300 SUS VISCOSITY
5001G	1 GALLON CONTAINER OF REFRIGERATION MINERAL OIL 500 SUS VISCOSITY
5005G	5 GALLON CONTAINER OF REFRIGERATION MINERAL OIL 500 SUS VISCOSITY
50055G	55 GALLON CONTAINER OF REFRIGERATION MINERAL OIL 500 SUS VISCOSITY
1TD	1 GALLON CONTAINER OF CAPELLA OIL 68 ISO VISCOSITY
5TD	5 GALLON CONTAINER OF CAPELLA OIL 68 ISO VISCOSITY
55TD	55 GALLON CONTAINER OF CAPELLA OIL 68 ISO VISCOSITY
PE321P	1 GALLON CONTAINER OF POLYOL ESTER LUBRICANT 32 ISO VISCOSITY
PE321Q	1 GALLON CONTAINER OF POLYOL ESTER LUBRICANT 32 ISO VISCOSITY
PE321G	1 GALLON CONTAINER OF POLYOL ESTER LUBRICANT 32 ISO VISCOSITY
PE681P	1 GALLON CONTAINER OF POLYOL ESTER LUBRICANT 68 ISO VISCOSITY
PE681Q	1 GALLON CONTAINER OF POLYOL ESTER LUBRICANT 68 ISO VISCOSITY
PE681G	1 GALLON CONTAINER OF POLYOL ESTER LUBRICANT 68 ISO VISCOSITY
VPO1P	1 GALLON CONTAINER OF VACUUM PUMP OIL 46 VISCOSITY
VPO1Q	1 GALLON CONTAINER OF VACUUM PUMP OIL 46 VISCOSITY
VPO1G	1 GALLON CONTAINER OF VACUUM PUMP OIL 46 VISCOSITY
VPO5G	5 GALLON CONTAINER OF VACUUM PUMP OIL 46 VISCOSITY
VPO55G	55 GALLON CONTAINER OF VACUUM PUMP OIL 46 VISCOSITY
WF32	1 GALLON CONTAINER OF CAPELLA OIL 32 ISO VISCOSITY
WF325	5 GALLON CONTAINER OF CAPELLA OIL 32 ISO VISCOSITY
WF3255	55 GALLON CONTAINER OF CAPELLA OIL 32 ISO VISCOSITY

CYLINDER REFURBISHING

PART NO.	DESCRIPTION
CYLDISP	DISPOSAL OF EMPTY NON-REFILLABLE CYLINDER
3050HST	HYDROSTATIC TESTING – 30 – 40 – 50 LB. CYLINDERS
125HST	HYDROSTATIC TESTING 125 LB. CYLINDER
240HST	HYDROSTATIC TESTING 240 LB. CYLINDER
1/2TONHST	HYDROSTATIC TESTING ½ TON CYLINDER
TONHST	HYDROSTATIC TESTING TON CYLINDER
3050HSRT	HYDROSTATIC TESTING & REFURBISHING – 30 – 40 – 50 LB. CYLINDERS
125HSRT	HYDROSTATIC TESTING & REFURBISHING 125 LB. CYLINDER
240HSRT	HYDROSTATIC TESTING & REFURBISHING 240 LB. CYLINDER
1/2TONHSRT	HYDROSTATIC TESTING & REFURBISHING ½ TON CYLINDER
TONHSRT	HYDROSTATIC TESTING & REFURBISHING TON CYLINDER

ASHRAE # (TRADE NAME)	COMPONENTS (WEIGHT %)	TYPE	TEMP. GLIDE (F)	LUBRICANTS	COMMENTS
R-123	pure	HCFC	0	MINERAL OIL or ALKYL BENZENE	Similar to R-11 - low pressure centrifugal chillers.
R-124	pure	HCFC	0	MINERAL OIL or ALKYL BENZENE	Similar to R-114 - high ambient air conditioning.
R-134a	pure	HFC	0	POLYOLESTER	HFC - new systems, med temp refrig, auto AC. Retrofit involves oil flushing.
R-22	pure	HCFC	0	MINERAL OIL or ALKYL BENZENE	New refrigeration systems, retrofit R-12 systems involves equipment changes. Standard for AC.
R-23	pure	HFC	0	POLYOLESTER	Properties similar to R-13; runs hotter on discharge side. Very low temperature refrigeration.
R-401A (MP 39)	22/152a/124 (53/13/34)	HCFC BLEND	8	ALKYL BENZENE OR MO/AB MIX	Retrofit blend for R-12; higher glide and discharge pressure/temp.
R-401B (MP 66)	22/152a/124 (61/11/28)	HCFC BLEND	8	ALKYL BENZENE OR MO/AB MIX	Retrofit blend for R-12 at lower temperatures (boost to capacity <-20F), also similar to R-500
R-402A (HP 80)	125/290/22 (60/2/38)	HCFC BLEND	2.5	ALKYL BENZENE OR MO/AB MIX	Retrofit blend for R-502; higher discharge pressure than 502.
R-402B (HP 81)	125/290/22 (38/2/60)	HCFC BLEND	2.5	ALKYL BENZENE OR MO/AB MIX	Retrofit blend for R-502 in ice machines; higher discharge temp.
R-403B ISCEON 69L	290/22/218 (5/56/39)	HCFC BLEND	2.5	MINERAL OIL or ALKYL BENZENE	Has been used successfully in 13B1 type equipment. (Lower evaporator pressures - in vacuum)
R-404A (HP62,FX70)	125/143a/134a (44/52/4)	HFC BLEND	1.5	POLYOLESTER	HFC blend - long term new or retrofit for R-502 (oil flush required).
R-407C (SUVA9000)	32/125/134a (23/25/52)	HFC BLEND	10	POLYOLESTER	HFC blend; similar properties to R-22, higher glide. Potential new equipment or retrofit for AC.
R-408A (FX 10)	125/143a/22 (7/46/47)	HCFC BLEND	1	MINERAL OIL or ALKYL BENZENE	Retrofit blend for R-502. Very close property match, slightly higher discharge temp.
R-409A (FX 56)	22/124/142b (60/25/15)	HCFC BLEND	12	MINERAL OIL or ALKYL BENZENE	Retrofit blend for R-12; higher glide and discharge pressure/temp. Similar to R-500 at AC temps.
R-410A (AZ 20)	32/125 (50/50)	HFC BLEND	0.2	POLYOLESTER	HFC blend for new AC systems; higher pressures, new equipment only.
R-414B (HOT SHOT)	22/600a/124/142b (50/1.5/39/9.5)	HCFC BLEND	12	MINERAL OIL or ALKYL BENZENE	Retrofit blend for R-12; lower R-22 content blend, lower head pressure. Approved for auto AC.
R-416A (FRIGC FR12)	134a/124/600 (59/39/2)	HCFC BLEND	2.5	POLYOLESTER	Retrofit blend for R-12; lower R-22 content blend, lower head pressure. Approved for auto AC.
R417A (NU-22)	125/134a/600a (46.6/50/3.4)	HFC BLEND	6	MINERAL OIL, AB, OR POE	HFC blend; similar properties to R-22, higher glide. Potential new equipment or retrofit for AC, refrig,
R-507 (AZ 50)	125/143a (50/50)	HFC BLEND	0	POLYOLESTER	HFC blend - long term new or retrofit for R-502 (oil flush required).
R-508B SUVA 95	23/116	HFC BLEND	0	POLYOLESTER	Properties similar to R-503; can be used for R-503 or R-13 very low temp systems.

ASHRAE # (TRADE NAME)	COMPONENTS (WEIGHT %)	CHARGING (%ORIGINAL)	APPLICATION COMMENTS
Very Low Temperature and Cascade Refrigeration (R-13 and R-503 type)			
R-23	pure	95%	R-13 systems can retrofit to R-23 (but suffer higher heat at discharge) or R-508B (but the pressures are different). R-503 systems should use R-508B. R-13B1 systems can operate with R-403B, but often in vacuum conditions.
R-508B SUVA 95	23/116	13: 105-110% 503: 90-95%	
R-403B ISCEON 69L	290/22/218 (5/56/39)	N/A	
Low-Medium Temperature Refrigeration (R-502 type)			
R-22	pure	100-105%	<p><u>Overall Concerns:</u> Discharge temperature is important - can't tolerate large increase. Higher discharge pressure can affect controls. Oil return is traditionally a problem in 502 low temp. Most blends are very low glide (no problems).</p> <p><u>Retrofit Recommendations (in order of preference based on performance/ease of use):</u> R-408A Closest match to R-502 properties and performance. Slightly higher dis. Temp. R-402A Higher discharge pressure, lower discharge temperature than 408A. R-402B Similar discharge pressure, higher discharge pressure. Good for ice machines. All retrofit blends should consider oil change to AB in order to improve oil circulation. R-404A or R-507 can be used to retrofit, however mineral oil must be flushed, POE used. <u>R-22 Refrigeration Options.</u> R-404A or R-507 can be used to retrofit, however mineral oil must be flushed, POE used, and system components (valves, etc.) may need to be changed. R-417A Warmer temps with existing oils. Loses performance and needs POE at low temp. <u>Long Term HFC Options.</u> R-404A and R-507 Off the shelf equipment, interchangeable with each other.</p>
R-402A (HP 80)	125/290/22 (60/2/38)	95-100%	
R-402B (HP 81)	125/290/22 (38/2/60)	95-100%	
R-404A (HP62,FX70)	125/143a/134a (44/52/4)	85-90%	
R-408A (FX 10)	125/143a/22 (7/46/47)	85-90%	
R-507 (AZ 50)	125/143a (50/50)	85-90%	
Low-Medium Temperature Refrigeration (R-12 type)			
R-22	pure	N/A	<p><u>Overall Concerns:</u> Match R-12 evaporator conditions (slightly higher discharge pressures OK). Oil return must be addressed. Temperature glide not a problem in most applications.</p> <p><u>Retrofit Recommendations (in order of preference based on performance/ease of use):</u> R-409A Better at lower temperatures, maintains performance, higher discharge T and P. R-414B Better at warmer temperatures, lower discharge temp than 409A. R-401A Good overall performance, need AB oil below 30F coil temps. R-416A Biggest change in properties, poor low temp performance <u>NRI does not carry.</u> R-406A Very similar to R-414B. Freeze 12, Freezone, RB 276: Similar to 416A (134a based, not good in low temp)</p>
R-134a	pure	90%	
R-401A (MP 39)	22/152a/124 (53/13/34)	80-85%	
R-401B (MP 66)	22/152a/124 (61/11/28)	80-85%	
R-409A (FX 56)	22/124/142b (60/25/15)	80-85%	
Medium-High Temperature Refrigeration (R-12 type)			
R-414B (HOT SHOT)	22/600a/124/142b (50/1.5/39/9.5)	80-85%	<p><u>Overall Concerns:</u> Higher application temps will drive up head pressure and discharge temp. These blends will lessen the abuse on the system but cost some capacity. Retrofit Recommendations (in order of NRI preference based on performance/ease of use): R-414B, 416A Lower, or no, R-22 cuts down on discharge temperature/pressure. R-401A, R-401B, R-409A for R-12 or R-500 air conditioning (direct expansion systems)</p>
R-416A (FRIGC FR12)	134a/124/600 (59/39/2)	90-95%	
Air Conditioning (R-22 type)			
R-407C (SUVA9000)	32/125/134a (23/25/52)	95-100%	<p><u>Overall Concerns:</u> R-22 availability and price make retrofitting a less attractive option, however it is possible to use R-407C (POE flush) or R-417A for retrofitting.</p> <p>New Equipment is being designed around R-410A (higher efficiency models), although it is possible that the R-22 "look alike" blends may be used also. Decision time frame depends on the new Energy Efficiency guidelines from DOE. (Residential, 2006)</p>
R-410A (AZ 20)	32/125 (50/50)	N/A	
R417A (NU-22)	125/134a/600a (46.6/50/3.4)	95-100%	
High Ambient and Centrifugal Chillers			
R-124	pure	N/A	<p>R-114 high ambient AC can use R-124 or very large R-134a systems. Centrifugal chillers require major equipment upgrades to retrofit to another refrigerant. Chiller manufacturers will need to be consulted for such jobs.</p>
R-123	pure	N/A	

Physical Properties of Refrigerants	R-11	R-12
Environmental Classification	CFC	CFC
Molecular Weight	137.4	120.9
Boiling Point (1 atm, F)	74.7	-21.6
Critical Pressure (psia)	639.3	600
Critical Temperature (F)	388	233.5
Critical Density (lb./ft ³)	34.6	35.3
Liquid Density (70 F, lb./ft ³)	92.73	82.96
Vapor Density (bp, lb./ft ³)	0.365	0.393
Heat of Vaporization (bp, BTU/lb.)	77.9	71.2
Specific Heat Liquid (70 F, BTU/lb. F)	0.2093	0.2324
Specific Heat Vapor (1 atm, 70 F, BTU/lb. F)	0.1444 (sat)	0.1455
Ozone Depletion Potential (CFC 11 = 1.0)	1.0	1.0
Global Warming Potential (CO ₂ = 1.0)	4680	10720
ASHRAE Standard 34 Safety Rating	A1	A1

Available in the following sizes:

R-11

- 100R11 100 lb drum
- 200R11 200 lb drum
- 650R11 650 lb drum
- 1100R11 ½ ton cylinder*
- 2200R11 1 ton cylinder*

R-12

- 012R12 12 oz cans
- 30R12 30 lb cylinder
- 50R12 50 lb cylinder
- 145R12 145 lb cylinder*
- 1000R12 ½ ton cylinder*
- 2000R12 ton cylinder*

* Deposit required

National Refrigerants still has significant quantities of CFC refrigerants for sale. As an EPA Certified Reclaimer we are able to consistently return used R-11, R-12, and other CFCs to ARI-700 specifications for purity.

R-11

Applications: Large, low-pressure centrifugal chillers. This type of chiller provides a very large amount of chilled water for air conditioning purposes (office buildings, hotels, etc). The equipment and charge size are usually quite large.

Retrofitting: R-123 is being successfully used to retrofit R-11 chillers. Hardware modifications are needed, however, and retrofit jobs are typically done with the help of OEMS.

R-12

Applications: Large centrifugal chillers, reciprocating chillers, open drive AC, process cooling, high-medium-low temp refrigeration (large and small systems).

Retrofitting To:	R-134a	page 87
	R-401A, R-401B	page 88
	R-409A	page 88
	R-414B	page 88
	R-416A	page 89

Pressure-Temperature Chart

R-11 psig	Temp (F)	R-12 psig
	-40	11.0
	-35	8.4
	-30	5.5
	-25	2.3
27.0	-20	0.6
26.5	-15	2.4
26.0	-10	4.5
25.4	-5	6.7
24.7	0	9.2
23.9	5	11.8
23.1	10	14.6
22.1	15	17.7
21.1	20	21.0
19.9	25	24.6
18.6	30	28.5
17.2	35	32.6
15.6	40	37.0
13.9	45	41.7
12.0	50	46.7
10.0	55	52.0
7.8	60	57.7
5.4	65	63.8
2.8	70	70.2
0.0	75	77.0
1.5	80	84.2
3.2	85	91.8
4.9	90	99.8
6.8	95	108
8.8	100	117
10.9	105	127
13.2	110	136
15.6	115	147
18.2	120	158
21.0	125	169
24.0	130	181
27.1	135	194
30.4	140	207
34.0	145	220
37.7	150	234

THERMODYNAMIC PROPERTIES OF R-11

Temp [F]	Pressure [psia]	Density (L) [lb/ft ³]	Density (V) [lb/ft ³]	Enthalpy (L) [Btu/lb]	Enthalpy (V) [Btu/lb]	Entropy (L) [Btu/R-lb]	Entropy (V) [Btu/R-lb]
30	5.6	95.93	0.1481	14.14	95.94	0.03112	0.1982
35	6.3	95.54	0.1654	15.16	96.56	0.03321	0.1977
40	7.0	95.14	0.1842	16.19	97.17	0.03528	0.1973
45	7.9	94.75	0.2047	17.23	97.79	0.03733	0.197
50	8.8	94.35	0.2269	18.26	98.41	0.03937	0.1966
55	9.8	93.95	0.2509	19.30	99.02	0.04139	0.1963
60	10.9	93.55	0.2769	20.34	99.64	0.0434	0.196
65	12.1	93.14	0.3049	21.39	100.3	0.0454	0.1957
70	13.4	92.73	0.3351	22.44	100.9	0.04738	0.1955
75	14.8	92.32	0.3676	23.49	101.5	0.04935	0.1952
80	16.3	91.91	0.4024	24.54	102.1	0.05131	0.1950
85	17.9	91.50	0.4397	25.60	102.7	0.05326	0.1948
90	19.7	91.08	0.4797	26.66	103.3	0.05519	0.1946
95	21.6	90.66	0.5224	27.73	103.9	0.05711	0.1945
100	23.6	90.23	0.5680	28.80	104.5	0.05902	0.1943
105	25.7	89.81	0.6167	29.87	105.1	0.06092	0.1942
110	28.1	89.38	0.6684	30.94	105.7	0.06281	0.1941
115	30.5	88.94	0.7235	32.02	106.3	0.06469	0.1940
120	33.2	88.51	0.7820	33.11	106.9	0.06656	0.1939
125	36.0	88.07	0.8442	34.20	107.5	0.06842	0.1939
130	38.9	87.62	0.910	35.29	108.1	0.07027	0.1938
135	42.1	87.17	0.980	36.39	108.7	0.07211	0.1937
140	45.4	86.72	1.054	37.49	109.3	0.07394	0.1937
145	49.0	86.26	1.132	38.59	109.9	0.07576	0.1937
150	52.8	85.80	1.215	39.70	110.5	0.07758	0.1936
155	56.7	85.33	1.302	40.82	111.0	0.07939	0.1936
160	60.9	84.86	1.394	41.94	111.6	0.08119	0.1936
165	65.3	84.39	1.492	43.06	112.2	0.08298	0.1936
170	70.0	83.91	1.594	44.19	112.7	0.08476	0.1936
175	74.9	83.42	1.702	45.33	113.3	0.08654	0.1936
180	80.0	82.93	1.816	46.47	113.8	0.08832	0.1936
185	85.4	82.43	1.936	47.62	114.4	0.09008	0.1936
190	91.1	81.93	2.062	48.77	114.9	0.09184	0.1936
195	97.1	81.42	2.195	49.93	115.4	0.09360	0.1937
200	103.3	80.90	2.335	51.09	116.0	0.09535	0.1937
205	109.8	80.38	2.482	52.26	116.5	0.09710	0.1937
210	116.7	79.85	2.636	53.44	117.0	0.09884	0.1937
215	123.8	79.31	2.799	54.62	117.5	0.1006	0.1937
220	131.3	78.76	2.970	55.82	118.0	0.1023	0.1938
225	139.1	78.21	3.149	57.01	118.5	0.1040	0.1938
230	147.2	77.65	3.338	58.22	118.9	0.1058	0.1938
235	155.6	77.08	3.536	59.43	119.4	0.1075	0.1938
240	164.5	76.50	3.745	60.65	119.8	0.1092	0.1938

THERMODYNAMIC PROPERTIES OF R-12

Temp [F]	Pressure [psia]	Density (L) [lb/ft ³]	Density (V) [lb/ft ³]	Enthalpy (L) [Btu/lb]	Enthalpy (V) [Btu/lb]	Entropy (L) [Btu/R-lb]	Entropy (V) [Btu/R-lb]
-60	5.4	96.63	0.1537	-4.145	70.99	-0.01010	0.1779
-55	6.2	96.14	0.1756	-3.115	71.56	-0.00754	0.1770
-50	7.1	95.66	0.1999	-2.081	72.13	-0.00501	0.1761
-45	8.1	95.17	0.2268	-1.043	72.70	-0.00249	0.1753
-40	9.3	94.68	0.2565	0.000	73.27	0.00000	0.1746
-35	10.6	94.18	0.289	1.047	73.84	0.00247	0.1739
-30	12.0	93.68	0.3247	2.098	74.41	0.00493	0.1732
-25	13.5	93.18	0.3637	3.154	74.98	0.00736	0.1726
-20	15.2	92.67	0.4063	4.214	75.55	0.00978	0.1720
-15	17.1	92.16	0.4525	5.280	76.11	0.01218	0.1715
-10	19.2	91.65	0.5028	6.350	76.68	0.01457	0.1710
-5	21.4	91.13	0.5573	7.425	77.24	0.01693	0.1705
0	23.8	90.61	0.6162	8.505	77.80	0.01929	0.1700
5	26.4	90.08	0.6798	9.591	78.35	0.02162	0.1696
10	29.3	89.55	0.7483	10.68	78.90	0.02395	0.1692
15	32.4	89.02	0.8221	11.78	79.45	0.02625	0.1688
20	35.7	88.48	0.9013	12.88	80.00	0.02855	0.1685
25	39.3	87.93	0.9864	13.99	80.54	0.03083	0.1681
30	43.1	87.38	1.078	15.10	81.07	0.03310	0.1678
35	47.2	86.82	1.175	16.22	81.61	0.03536	0.1675
40	51.6	86.25	1.279	17.35	82.13	0.03761	0.1673
45	56.3	85.68	1.391	18.48	82.65	0.03984	0.1670
50	61.3	85.10	1.510	19.62	83.17	0.04207	0.1668
55	66.6	84.52	1.637	20.77	83.68	0.04428	0.1665
60	72.3	83.92	1.772	21.92	84.18	0.04649	0.1663
65	78.4	83.32	1.915	23.08	84.67	0.04869	0.1661
70	84.8	82.71	2.068	24.25	85.16	0.05088	0.1659
75	91.5	82.09	2.231	25.43	85.64	0.05306	0.1657
80	98.7	81.47	2.404	26.61	86.11	0.05524	0.1655
85	106.3	80.83	2.588	27.80	86.58	0.05740	0.1653
90	114.3	80.18	2.783	29.01	87.03	0.05957	0.1651
95	122.7	79.52	2.991	30.22	87.47	0.06173	0.1649
100	131.6	78.85	3.211	31.44	87.90	0.06388	0.1648
105	141.0	78.16	3.445	32.67	88.32	0.06603	0.1646
110	150.8	77.46	3.694	33.91	88.73	0.06818	0.1644
115	161.1	76.75	3.958	35.16	89.12	0.07032	0.1642
120	172.0	76.02	4.238	36.43	89.50	0.07247	0.1640
125	183.3	75.28	4.537	37.70	89.87	0.07461	0.1638
130	195.2	74.51	4.855	38.99	90.22	0.07676	0.1636
135	207.7	73.73	5.193	40.30	90.55	0.07890	0.1634
140	220.7	72.93	5.554	41.61	90.86	0.08106	0.1632
145	234.4	72.10	5.939	42.95	91.15	0.08321	0.1629
150	248.6	71.24	6.351	44.30	91.42	0.08538	0.1627
155	263.5	70.36	6.792	45.67	91.66	0.08755	0.1624
160	279.0	69.45	7.265	47.06	91.87	0.08973	0.1621

Physical Properties of Refrigerants	R-13
Environmental Classification	CFC
Molecular Weight	104.5
Boiling Point (1 atm, F)	-114.3
Critical Pressure (psia)	567.8
Critical Temperature (F)	84.6
Critical Density (lb./ft ³)	35.9
Liquid Density (70 F, lb./ft ³)	72.7
Vapor Density (bp, lb./ft ³)	0.4332
Heat of Vaporization (bp, BTU/lb.)	64.35
Specific Heat Liquid (70 F, BTU/lb. F)	0.2876
Specific Heat Vapor (1 atm, 70 F, BTU/lb. F)	0.1445
Ozone Depletion Potential (CFC 11 = 1.0)	1.0
Global Warming Potential (CO ₂ = 1.0)	14190
ASHRAE Standard 34 Safety Rating	A1

Available in the following sizes:

R-13

5R13 5 lb cylinder

9R13 9 lb cylinder*

23R13 23 lb cylinder*

80R13 80 lb cylinder*

*Deposit Required

Very low temperature refrigeration systems typically operate in two or more stages (cascade type systems). It would be nearly impossible to achieve low temperatures in a single stage with an inexpensive compressor. The traditional cascade system has a low temperature stage that uses the lower boiling point gas, such as R-13 or R-503, and a high stage that typically uses R-12, R-22 or R-502.

The high stage evaporator provides the correct condensation temperature for the low stage so that compressors in both stages can run at "normal" pressures.

R-13

Applications: Very low temperature refrigeration (low stage of a cascade system)

Retrofitting: R-23 or R-508B page (to be added)

Pressure-Temp Chart

Temp (F)	R-13 psig
-120	4.5
-115	0.3
-110	2.1
-105	4.7
-100	7.6
-95	10.8
-90	14.3
-85	18.2
-80	22.5
-75	27.2
-70	32.3
-65	37.8
-60	43.9
-55	50.4
-50	57.5
-45	65.1
-40	73.3
-35	82.1
-30	91.6
-25	102
-20	113
-15	122
-10	136
-5	149
0	163
5	177
10	193
15	209
20	226
25	244
30	264
35	284
40	305

THERMODYNAMIC PROPERTIES OF R-13

<u>Temp</u> [F]	<u>Pressure</u> [psia]	<u>Density (L)</u> [lb/ft ³]	<u>Density (V)</u> [lb/ft ³]	<u>Enthalpy (L)</u> [Btu/lb]	<u>Enthalpy (V)</u> [Btu/lb]	<u>Entropy (L)</u> [Btu/R-lb]	<u>Entropy (V)</u> [Btu/R-lb]
-140	6.4	98.20	0.2008	-21.91	45.08	-0.059	0.1506
-135	7.7	97.56	0.2359	-20.89	45.58	-0.05582	0.1489
-130	9.1	96.92	0.2756	-19.86	46.08	-0.05268	0.1473
-125	10.7	96.27	0.3204	-18.82	46.57	-0.04957	0.1458
-120	12.5	95.62	0.3707	-17.78	47.06	-0.04649	0.1444
-115	14.5	94.96	0.4269	-16.73	47.55	-0.04343	0.1430
-110	16.8	94.30	0.4894	-15.67	48.03	-0.04040	0.1418
-105	19.3	93.63	0.5588	-14.61	48.51	-0.03739	0.1406
-100	22.2	92.95	0.6356	-13.54	48.98	-0.03441	0.1394
-95	25.4	92.27	0.7203	-12.46	49.45	-0.03145	0.1383
-90	28.9	91.58	0.8135	-11.37	49.91	-0.02851	0.1373
-85	32.7	90.87	0.9158	-10.28	50.37	-0.02559	0.1363
-80	37.0	90.17	1.028	-9.173	50.82	-0.02269	0.1353
-75	41.6	89.45	1.150	-8.061	51.26	-0.01980	0.1344
-70	46.7	88.72	1.283	-6.939	51.70	-0.01693	0.1335
-65	52.2	87.98	1.428	-5.809	52.12	-0.01408	0.1327
-60	58.2	87.23	1.586	-4.668	52.54	-0.01124	0.1319
-55	64.7	86.46	1.757	-3.517	52.95	-0.00841	0.1311
-50	71.7	85.69	1.942	-2.356	53.34	-0.00560	0.1304
-45	79.3	84.90	2.143	-1.184	53.73	-0.00280	0.1296
-40	87.4	84.10	2.360	0.000	54.11	0.00000	0.1289
-35	96.2	83.27	2.594	1.196	54.47	0.00279	0.1282
-30	105.6	82.44	2.848	2.405	54.82	0.00557	0.1276
-25	115.6	81.58	3.121	3.627	55.15	0.00834	0.1269
-20	126.4	80.71	3.416	4.863	55.47	0.01111	0.1262
-15	137.8	79.81	3.735	6.114	55.77	0.01388	0.1256
-10	150.0	78.89	4.078	7.381	56.06	0.01665	0.1249
-5	163.0	77.94	4.450	8.666	56.32	0.01943	0.1242
0	176.7	76.96	4.851	9.968	56.57	0.02220	0.1236
5	191.3	75.96	5.286	11.29	56.79	0.02499	0.1229
10	206.8	74.91	5.756	12.63	56.98	0.02778	0.1222
15	223.1	73.83	6.267	14.00	57.15	0.03059	0.1215
20	240.4	72.71	6.823	15.39	57.28	0.03342	0.1207
25	258.6	71.54	7.430	16.81	57.38	0.03627	0.1200
30	277.9	70.31	8.094	18.27	57.43	0.03915	0.1191
35	298.2	69.01	8.824	19.76	57.44	0.04206	0.1182
40	319.5	67.64	9.632	21.29	57.39	0.04503	0.1173

Physical Properties of Refrigerants	R-22	Available in the following sizes:
Environmental Classification	HCFC	R-22 15R22 15 lb cylinder 30R22 30 lb cylinder 50R22 50 lb cylinder 125R22 125 lb cylinder* 1000R22 ½ ton cylinder* 1750R22 ton cylinder* *Deposit Required
Molecular Weight	86.5	
Boiling Point (1 atm, F)	-41.5	
Critical Pressure (psia)	723.7	
Critical Temperature (F)	205.1	
Critical Density (lb./ft ³)	32.7	
Liquid Density (70 F, lb./ft ³)	75.3	
Vapor Density (bp, lb./ft ³)	0.294	
Heat of Vaporization (bp, BTU/lb.)	100.5	
Specific Heat Liquid (70 F, BTU/lb. F)	0.2967	
Specific Heat Vapor (1 atm, 70 F, BTU/lb. F)	0.1573	
Ozone Depletion Potential (CFC 11 = 1.0)	0.05	
Global Warming Potential (CO ₂ = 1.0)	1780	
ASHRAE Standard 34 Safety Rating	A1	

The dominant refrigerant in residential and commercial air conditioning applications, also used in refrigeration and as a blend component since the phaseout of CFCs. R-22 is subject to production restrictions and eventual phaseout in 2020. (It cannot be used in new equipment after 2010.)

R-22

Applications: Refrigeration - low and medium temperature commercial and stand-alone systems, industrial process cooling, glycol and water chillers, commercial and residential air conditioning and heat pumps.

Retrofitting: R-407C page 90
 R-417A page 90
 R-404A or R-507 page (to be added)

Pressure-Temp Chart

Temp (F)	R-22 (psig)
-40	0.5
-35	2.6
-30	4.9
-25	7.4
-20	10.1
-15	13.2
-10	16.5
-5	20.1
0	24.0
5	28.2
10	32.8
15	37.7
20	43.0
25	48.8
30	54.9
35	61.5
40	68.5
45	76.0
50	84.0
55	92.6
60	102
65	111
70	121
75	132
80	144
85	156
90	168
95	182
100	196
105	211
110	226
115	243
120	260
125	278
130	297
135	317
140	337
145	359
150	382

THERMODYNAMIC PROPERTIES OF R-22

Temp [F]	Pressure [psia]	Density (L) [lb/ft ³]	Density (V) [lb/ft ³]	Enthalpy (L) [Btu/lb]	Enthalpy (V) [Btu/lb]	Entropy (L) [Btu/R-lb]	Entropy (V) [Btu/R-lb]
-60	8.8	89.82	0.1827	-5.189	98.09	-0.01264	0.2458
-55	10.2	89.33	0.2087	-3.897	98.66	-0.00943	0.2440
-50	11.7	88.83	0.2374	-2.602	99.22	-0.00626	0.2423
-45	13.4	88.33	0.2692	-1.303	99.79	-0.00311	0.2407
-40	15.3	87.82	0.3042	0.000	100.3	0.00000	0.2391
-35	17.3	87.32	0.3427	1.308	100.9	0.00309	0.2376
-30	19.6	86.80	0.3849	2.620	101.4	0.00615	0.2361
-25	22.1	86.29	0.4310	3.937	102.0	0.00918	0.2348
-20	24.9	85.76	0.4813	5.260	102.5	0.01220	0.2334
-15	27.9	85.24	0.5360	6.588	103.0	0.01519	0.2321
-10	31.2	84.71	0.5955	7.923	103.6	0.01815	0.2309
-5	34.8	84.17	0.6600	9.263	104.1	0.02110	0.2296
0	38.7	83.63	0.7299	10.61	104.6	0.02403	0.2285
5	43.0	83.08	0.8054	11.96	105.1	0.02694	0.2273
10	47.5	82.52	0.8868	13.33	105.6	0.02983	0.2263
15	52.5	81.96	0.9746	14.69	106.1	0.03270	0.2252
20	57.8	81.39	1.069	16.07	106.5	0.03556	0.2242
25	63.5	80.82	1.171	17.46	107.0	0.03841	0.2231
30	69.7	80.24	1.280	18.85	107.4	0.04124	0.2222
35	76.2	79.65	1.396	20.25	107.9	0.04406	0.2212
40	83.3	79.05	1.522	21.66	108.3	0.04686	0.2203
45	90.8	78.44	1.656	23.08	108.7	0.04966	0.2194
50	98.8	77.83	1.799	24.51	109.1	0.05244	0.2185
55	107.3	77.20	1.952	25.96	109.5	0.05522	0.2176
60	116.3	76.57	2.116	27.41	109.9	0.05798	0.2167
65	125.9	75.92	2.291	28.87	110.3	0.06074	0.2159
70	136.1	75.27	2.478	30.35	110.6	0.06350	0.2150
75	146.9	74.60	2.678	31.84	110.9	0.06625	0.2142
80	158.3	73.92	2.891	33.34	111.2	0.06899	0.2133
85	170.4	73.23	3.118	34.86	111.5	0.07173	0.2125
90	183.1	72.52	3.361	36.39	111.8	0.07447	0.2117
95	196.5	71.80	3.620	37.94	112.0	0.07721	0.2108
100	210.6	71.06	3.897	39.50	112.3	0.07996	0.2100
105	225.5	70.30	4.193	41.08	112.5	0.08270	0.2091
110	241.1	69.52	4.510	42.69	112.7	0.08545	0.2083
115	257.5	68.72	4.849	44.31	112.8	0.08821	0.2074
120	274.7	67.90	5.213	45.95	112.9	0.09098	0.2065
125	292.7	67.05	5.604	47.62	113.0	0.09376	0.2056
130	311.6	66.18	6.024	49.32	113.0	0.09656	0.2046
135	331.4	65.27	6.477	51.04	113.0	0.09937	0.2036
140	352.1	64.32	6.966	52.80	113.0	0.1022	0.2026
145	373.7	63.34	7.497	54.59	112.9	0.1051	0.2015
150	396.4	62.31	8.075	56.42	112.8	0.1080	0.2004
155	420.0	61.22	8.706	58.31	112.5	0.1110	0.1992
160	444.7	60.07	9.400	60.24	112.2	0.1140	0.1979

Physical Properties of Refrigerants	R-23
Environmental Classification	HFC
Molecular Weight	70
Boiling Point (1 atm, F)	-115.6
Critical Pressure (psia)	701.4
Critical Temperature (F)	78.7
Critical Density (lb./ft ³)	32.8
Liquid Density (20 F, lb./ft ³)	67.46
Vapor Density (bp, lb./ft ³)	0.29
Heat of Vaporization (bp, BTU/lb.)	102.7
Specific Heat Liquid (20 F, BTU/lb. F)	0.4162
Specific Heat Vapor (1 atm, 20 F, BTU/lb. F)	0.1663
Ozone Depletion Potential (CFC 11 = 1.0)	0
Global Warming Potential (CO ₂ = 1.0)	12240
ASHRAE Standard 34 Safety Rating	A1

Available in the following sizes:

R-23

- 5R13 5 lb cylinder
- 9R13 9 lb cylinder*
- 20R13 20 lb cylinder*
- 70R13 70 lb cylinder*

*Deposit Required

Very low temperature refrigeration systems typically operate in two or more stages (cascade type systems). It would be nearly impossible to achieve low temperatures in a single stage with an inexpensive compressor. The traditional cascade system has a low temperature stage that uses the lower boiling point gas, such as R-13 or R-503, and a high stage that typically uses R-12, R-22 or R-502. (R-23 has very similar properties to R-13, although it will generate higher discharge temperatures.)

The high stage evaporator provides the correct condensation temperature for the low stage so that compressors in both stages can run at “normal” pressures.

R-23

Applications: Very low temperature refrigeration (low stage of a cascade system)

Retrofitting: to replace R-13 page (to be added)

Pressure-Temp Chart

Temp (F)	R-23 (psig)
-125	7.8"
-120	4.0"
-115	0.3
-110	2.9
-105	5.8
-100	9.0
-95	12.7
-90	16.7
-85	21.3
-80	26.3
-75	31.8
-70	37.9
-65	44.6
-60	52.0
-55	60.0
-50	68.7
-45	78.1
-40	88.3
-35	99.4
-30	111
-25	124
-20	138
-15	152
-10	168
-5	185
0	203
5	222
10	242
15	264
20	287

THERMODYNAMIC PROPERTIES OF R-23

Temp [F]	Pressure [psia]	Density (L) [lb/ft ³]	Density (V) [lb/ft ³]	Enthalpy (L) [Btu/lb]	Enthalpy (V) [Btu/lb]	Entropy (L) [Btu/R-lb]	Entropy (V) [Btu/R-lb]
-140	6.3	92.72	0.1312	-30.60	77.43	-0.08247	0.2555
-135	7.6	92.20	0.1562	-29.15	77.98	-0.07799	0.2520
-130	9.1	91.66	0.1850	-27.70	78.52	-0.07356	0.2486
-125	10.8	91.12	0.2178	-26.25	79.05	-0.06919	0.2455
-120	12.8	90.57	0.2550	-24.78	79.58	-0.06486	0.2424
-115	15.1	90.00	0.2972	-23.31	80.09	-0.06058	0.2394
-110	17.6	89.43	0.3446	-21.84	80.59	-0.05634	0.2366
-105	20.6	88.84	0.3978	-20.35	81.09	-0.05214	0.2339
-100	23.8	88.24	0.4572	-18.86	81.56	-0.04798	0.2312
-95	27.5	87.63	0.5234	-17.35	82.03	-0.04385	0.2287
-90	31.6	87.00	0.5970	-15.84	82.48	-0.03975	0.2262
-85	36.1	86.36	0.6784	-14.32	82.92	-0.03568	0.2238
-80	41.2	85.70	0.7684	-12.78	83.34	-0.03163	0.2215
-75	46.7	85.03	0.8675	-11.23	83.75	-0.02762	0.2193
-70	52.9	84.35	0.9765	-9.671	84.14	-0.02362	0.2171
-65	59.6	83.64	1.096	-8.097	84.51	-0.01964	0.2150
-60	67.0	82.93	1.227	-6.509	84.86	-0.01569	0.2129
-55	75.0	82.19	1.370	-4.906	85.19	-0.01175	0.2109
-50	83.7	81.43	1.527	-3.288	85.50	-0.00782	0.2089
-45	93.2	80.66	1.698	-1.653	85.79	-0.00390	0.2070
-40	103.5	79.86	1.884	0.000	86.06	0.00000	0.2051
-35	114.6	79.04	2.087	1.671	86.30	0.00390	0.2032
-30	126.6	78.20	2.307	3.361	86.52	0.00779	0.2013
-25	139.5	77.34	2.547	5.072	86.70	0.01168	0.1995
-20	153.3	76.44	2.808	6.806	86.86	0.01556	0.1976
-15	168.1	75.52	3.092	8.563	86.98	0.01946	0.1958
-10	184.0	74.57	3.402	10.34	87.06	0.02335	0.1940
-5	201.0	73.58	3.739	12.15	87.11	0.02726	0.1921
0	219.1	72.55	4.106	13.99	87.11	0.03119	0.1903
5	238.4	71.49	4.508	15.87	87.07	0.03513	0.1884
10	258.9	70.38	4.948	17.77	86.97	0.03910	0.1864
15	280.8	69.22	5.431	19.72	86.81	0.04310	0.1844
20	303.9	68.00	5.963	21.71	86.59	0.04715	0.1824
25	328.5	66.72	6.551	23.76	86.28	0.05124	0.1802
30	354.6	65.36	7.206	25.86	85.89	0.05541	0.1780
35	382.1	63.92	7.940	28.03	85.39	0.05966	0.1756
40	411.3	62.36	8.769	30.28	84.75	0.06402	0.1730

Physical Properties of Refrigerants	R-123	R-124
Environmental Classification	HCFC	HCFC
Molecular Weight	152.9	136.5
Boiling Point (1 atm, F)	82.1	10.3
Critical Pressure (psia)	531.1	527.1
Critical Temperature (F)	362.6	252.5
Critical Density (lb./ft ³)	34.3	34.6
Liquid Density (70 F, lb./ft ³)	91.95	85.5
Vapor Density (bp, lb./ft ³)	0.404	0.419
Heat of Vaporization (bp, BTU/lb.)	73.2	70.6
Specific Heat Liquid (70 F, BTU/lb. F)	0.2329	0.265
Specific Heat Vapor (1 atm, 70 F, BTU/lb. F)	0.1645 (sat)	0.1762
Ozone Depletion Potential (CFC 11 = 1.0)	0.0015	0.03
Global Warming Potential (CO ₂ = 1.0)	76	599
ASHRAE Standard 34 Safety Rating	B1	A1

Available in the following sizes:

R-123

100R123 100 lb drum
200R123 200 lb drum
650R123 650 lb drum
1100R123 ½ ton cylinder*
2200R123 1 ton cylinder*

R-124

30R124 30 lb cylinder
125R12 125 lb cylinder*
2000R124 ton cylinder*

*Deposit Required

R-123

Replaced R-11 in low pressure centrifugal chillers. New R-123 equipment has been engineered with the correct materials of construction and sized properly for the intended job. Retrofitting existing R-11 chillers to R-123 may require replacement seals, gaskets and other system components to obtain the correct operating conditions and prevent leakage.

Applications: Large, low-pressure centrifugal chillers.

Retrofitting: for R-11 chillers. Retrofit jobs are typically done with the help of OEMS.

R-124

Applications: used in retrofit blends, primarily R-12 alternatives, High ambient air conditioning

Pressure-Temp Chart

Temp (F)	R-123 (psig)	R-124 (psig)
-20	27.8	16.1
-15	27.4	14.1
-10	26.9	12.0
-5	26.4	9.6
0	25.9	6.9
5	25.2	3.9
10	24.5	0.6
15	23.8	1.6
20	22.8	3.5
25	21.8	5.7
30	20.7	8.1
35	19.5	10.5
40	18.1	13.2
45	16.6	16.1
50	14.9	19.2
55	13.0	22.6
60	11.2	26.3
65	8.9	30.2
70	6.5	34.4
75	4.1	38.9
80	1.2	43.7
85	0.9	48.8
90	2.5	54.2
95	4.3	60.0
100	6.1	66.1
105	8.1	72.6
110	10.3	79.5
115	12.6	86.8
120	15.1	94.5
125	17.8	103
130	20.6	111
135	23.6	120
140	26.8	130
145	30.2	140
150	33.9	150

THERMODYNAMIC PROPERTIES OF R-123

Temp [F]	Pressure [psia]	Density (L) [lb/ft ³]	Density (V) [lb/ft ³]	Enthalpy (L) [Btu/lb]	Enthalpy (V) [Btu/lb]	Entropy (L) [Btu/R-lb]	Entropy (V) [Btu/R-lb]
-20	1.0	99.54	0.03413	4.558	87.35	0.01061	0.1989
-15	1.2	99.14	0.03978	5.706	88.05	0.01320	0.1984
-10	1.4	98.73	0.04618	6.857	88.75	0.01578	0.1979
-5	1.7	98.33	0.05339	8.012	89.46	0.01833	0.1975
0	2.0	97.92	0.06149	9.170	90.16	0.02086	0.1971
5	2.3	97.51	0.07055	10.33	90.87	0.02337	0.1967
10	2.6	97.10	0.08067	11.50	91.58	0.02587	0.1964
15	3.0	96.69	0.09192	12.67	92.29	0.02834	0.1961
20	3.5	96.28	0.1044	13.84	93.01	0.03080	0.1958
25	4.0	95.86	0.1182	15.02	93.72	0.03324	0.1956
30	4.5	95.44	0.1334	16.20	94.44	0.03566	0.1954
35	5.1	95.02	0.1502	17.38	95.16	0.03806	0.1953
40	5.8	94.60	0.1686	18.57	95.88	0.04045	0.1952
45	6.5	94.17	0.1887	19.76	96.60	0.04282	0.1951
50	7.3	93.74	0.2106	20.96	97.32	0.04518	0.1950
55	8.2	93.31	0.2346	22.16	98.04	0.04752	0.1950
60	9.2	92.88	0.2606	23.36	98.76	0.04984	0.1949
65	10.3	92.44	0.2889	24.57	99.48	0.05215	0.1949
70	11.4	92.01	0.3195	25.78	100.2	0.05444	0.1949
75	12.7	91.56	0.3526	27.00	100.9	0.05673	0.1950
80	14.1	91.12	0.3883	28.22	101.6	0.05899	0.1950
85	15.6	90.67	0.4268	29.44	102.4	0.06124	0.1951
90	17.2	90.22	0.4682	30.67	103.1	0.06348	0.1952
95	18.9	89.77	0.5128	31.90	103.8	0.06571	0.1953
100	20.8	89.31	0.5605	33.14	104.5	0.06792	0.1955
105	22.8	88.85	0.6117	34.38	105.2	0.07012	0.1956
110	25.0	88.39	0.6664	35.63	106.0	0.07231	0.1958
115	27.3	87.92	0.7249	36.88	106.7	0.07449	0.1959
120	29.8	87.45	0.7874	38.13	107.4	0.07665	0.1961
125	32.4	86.98	0.8540	39.39	108.1	0.07881	0.1963
130	35.3	86.50	0.9249	40.66	108.8	0.08095	0.1965
135	38.3	86.01	1.000	41.93	109.5	0.08308	0.1967
140	41.5	85.52	1.081	43.20	110.2	0.08520	0.1969
145	44.9	85.03	1.166	44.48	110.9	0.08732	0.1972
150	48.5	84.53	1.256	45.76	111.6	0.08942	0.1974
155	52.3	84.03	1.353	47.05	112.3	0.09151	0.1976
160	56.4	83.52	1.454	48.35	113.0	0.09359	0.1979
165	60.7	83.01	1.562	49.65	113.7	0.09567	0.1981
170	65.2	82.49	1.676	50.95	114.3	0.09773	0.1984
175	70.0	81.96	1.797	52.27	115.0	0.09979	0.1987
180	75.0	81.43	1.925	53.58	115.7	0.1018	0.1989
185	80.3	80.89	2.060	54.91	116.3	0.1039	0.1992
190	85.9	80.34	2.203	56.24	117.0	0.1059	0.1995
195	91.7	79.79	2.354	57.57	117.7	0.1079	0.1997
200	97.9	79.23	2.513	58.92	118.3	0.1100	0.2000

THERMODYNAMIC PROPERTIES OF R-124

Temp [F]	Pressure [psia]	Density (L) [lb/ft ³]	Density (V) [lb/ft ³]	Enthalpy (L) [Btu/lb]	Enthalpy (V) [Btu/lb]	Entropy (L) [Btu/R-lb]	Entropy (V) [Btu/R-lb]
-40	3.8	97.03	0.1181	0	76.75	0	0.1829
-35	4.5	96.55	0.1359	1.222	77.46	0.00289	0.1824
-30	5.2	96.06	0.1557	2.449	78.17	0.00576	0.1820
-25	5.9	95.57	0.1779	3.681	78.88	0.00861	0.1816
-20	6.8	95.08	0.2024	4.918	79.59	0.01143	0.1813
-15	7.8	94.58	0.2295	6.159	80.30	0.01424	0.1810
-10	8.9	94.08	0.2594	7.406	81.01	0.01702	0.1807
-5	10.1	93.57	0.2924	8.657	81.72	0.01978	0.1805
0	11.4	93.06	0.3285	9.914	82.43	0.02253	0.1803
5	12.9	92.55	0.3680	11.18	83.14	0.02525	0.1801
10	14.5	92.04	0.4112	12.44	83.84	0.02796	0.1800
15	16.3	91.52	0.4583	13.72	84.55	0.03065	0.1799
20	18.3	90.99	0.5095	15.00	85.25	0.03332	0.1798
25	20.4	90.46	0.5651	16.28	85.95	0.03597	0.1797
30	22.7	89.93	0.6253	17.57	86.65	0.03861	0.1797
35	25.2	89.39	0.6904	18.87	87.35	0.04124	0.1797
40	27.9	88.84	0.7608	20.17	88.05	0.04385	0.1797
45	30.8	88.29	0.8366	21.48	88.74	0.04644	0.1797
50	34.0	87.73	0.9183	22.80	89.43	0.04902	0.1798
55	37.4	87.17	1.006	24.12	90.11	0.05159	0.1798
60	41.0	86.60	1.100	25.45	90.79	0.05415	0.1799
65	44.9	86.03	1.202	26.79	91.47	0.05669	0.1800
70	49.1	85.44	1.310	28.13	92.14	0.05922	0.1801
75	53.6	84.85	1.426	29.48	92.81	0.06174	0.1802
80	58.4	84.25	1.551	30.84	93.47	0.06425	0.1803
85	63.5	83.65	1.683	32.21	94.13	0.06676	0.1804
90	69.0	83.03	1.825	33.58	94.78	0.06925	0.1806
95	74.8	82.41	1.977	34.97	95.42	0.07173	0.1807
100	80.9	81.77	2.139	36.36	96.06	0.07420	0.1809
105	87.4	81.13	2.311	37.76	96.69	0.07667	0.1810
110	94.3	80.48	2.495	39.17	97.31	0.07913	0.1812
115	101.6	79.81	2.691	40.59	97.92	0.08158	0.1813
120	109.3	79.13	2.900	42.02	98.53	0.08403	0.1815
125	117.5	78.44	3.123	43.46	99.12	0.08648	0.1817
130	126.0	77.73	3.360	44.92	99.70	0.08892	0.1818
135	135.1	77.01	3.614	46.38	100.3	0.09135	0.1820
140	144.6	76.28	3.884	47.86	100.8	0.09379	0.1821
145	154.6	75.52	4.172	49.35	101.4	0.09622	0.1823
150	165.1	74.75	4.480	50.85	101.9	0.09866	0.1824
155	176.2	73.96	4.809	52.37	102.4	0.1011	0.1825
160	187.7	73.14	5.161	53.91	102.9	0.1035	0.1826
165	199.9	72.30	5.538	55.46	103.4	0.1060	0.1827
170	212.6	71.44	5.942	57.03	103.8	0.1084	0.1828
175	225.9	70.54	6.377	58.62	104.3	0.1109	0.1828
180	239.8	69.61	6.845	60.23	104.7	0.1134	0.1828

Physical Properties of Refrigerants	R-134a	Available in the following sizes:
Environmental Classification	HFC	R-134a 012R134a 12 oz cans 30R134a 30 lb cylinder A30R134a 30 lb auto AC 50R134a 50 lb cylinder 125R134a 125 lb cylinder* 1000R134a ½ ton cylinder* 2000R134a ton cylinder* *Deposit Required
Molecular Weight	102.3	
Boiling Point (1 atm, F)	-14.9	
Critical Pressure (psia)	588.3	
Critical Temperature (F)	213.8	
Critical Density (lb./ft ³)	32.0	
Liquid Density (70 F, lb./ft ³)	76.2	
Vapor Density (bp, lb./ft ³)	0.328	
Heat of Vaporization (bp, BTU/lb.)	93.3	
Specific Heat Liquid (70 F, BTU/lb. F)	0.3366	
Specific Heat Vapor (1 atm, 70 F, BTU/lb. F)	0.2021	
Ozone Depletion Potential (CFC 11 = 1.0)	0	
Global Warming Potential (CO ₂ = 1.0)	1320	
ASHRAE Standard 34 Safety Rating	A1	

A long-term, HFC alternative with similar properties to R-12. It has become the new industry standard refrigerant for automotive air conditioning and refrigerator/freezer appliances.

R-134a refrigerating performance will suffer at lower temperatures (below -10 F). Some traditional R-12 applications have used alternatives other than 134a for lower temperatures.

R-134a requires polyol ester (POE) lubricants. Traditional mineral oils and alkylbenzenes do not mix with HFC refrigerants and their use with 134a may cause operation problems or compressor failures. In addition, automotive AC systems may use polyalkaline glycols (PAGs), which are typically not seen in stationary equipment.

Both POEs and PAGs will absorb moisture, and hold onto it, to a much greater extent than traditional lubricants. The moisture will promote reactions in the lubricant as well as the usual problems associated with water (corrosion, acid formation). The best way to dry a wet HFC system is to rely on the filter drier. Deep vacuum will remove "free" water, but not the water that has absorbed into the lubricant.

R-134a

Applications: Appliances, refrigeration (commercial and self contained equipment), centrifugal chillers and automotive air conditioning.

Retrofitting: for R-12 page 87

Pressure-Temp Chart

Temp (F)	R-134a (psig)
-40	14.8
-35	12.5
-30	9.9
-25	6.9
-20	3.7
-15	0.6
-10	1.9
-5	4.0
0	6.5
5	9.1
10	11.9
15	15.0
20	18.4
25	22.1
30	26.1
35	30.4
40	35.0
45	40.1
50	45.5
55	51.3
60	57.5
65	64.1
70	71.2
75	78.8
80	86.8
85	95.4
90	104
95	114
100	124
105	135
110	147
115	159
120	171
125	185
130	199
135	214
140	229
145	246
150	263

THERMODYNAMIC PROPERTIES OF R-134a

Temp [F]	Pressure [psia]	Density (L) [lb/ft ³]	Density (V) [lb/ft ³]	Enthalpy (L) [Btu/lb]	Enthalpy (V) [Btu/lb]	Entropy (L) [Btu/R-lb]	Entropy (V) [Btu/R-lb]
-60	4.0	90.49	0.09689	-5.957	94.13	-0.01452	0.2359
-55	4.7	90.00	0.1127	-4.476	94.89	-0.01085	0.2347
-50	5.5	89.50	0.1305	-2.989	95.65	-0.00720	0.2336
-45	6.4	89.00	0.1505	-1.498	96.41	-0.00358	0.2325
-40	7.4	88.50	0.1729	0.000	97.17	0.00000	0.2315
-35	8.6	88.00	0.1978	1.503	97.92	0.00356	0.2306
-30	9.9	87.49	0.2256	3.013	98.68	0.00708	0.2297
-25	11.3	86.98	0.2563	4.529	99.43	0.01058	0.2289
-20	12.9	86.47	0.2903	6.051	100.2	0.01406	0.2282
-15	15.3	85.95	0.3277	7.580	100.9	0.01751	0.2274
-10	16.6	85.43	0.3689	9.115	101.7	0.02093	0.2268
-5	18.8	84.90	0.4140	10.66	102.4	0.02433	0.2262
0	21.2	84.37	0.4634	12.21	103.2	0.02771	0.2256
5	23.8	83.83	0.5173	13.76	103.9	0.03107	0.2250
10	26.6	83.29	0.5761	15.33	104.6	0.03440	0.2245
15	29.7	82.74	0.6401	16.90	105.3	0.03772	0.2240
20	33.1	82.19	0.7095	18.48	106.1	0.04101	0.2236
25	36.8	81.63	0.7848	20.07	106.8	0.04429	0.2232
30	40.8	81.06	0.8663	21.67	107.5	0.04755	0.2228
35	45.1	80.49	0.9544	23.27	108.2	0.05079	0.2224
40	49.7	79.90	1.050	24.89	108.9	0.05402	0.2221
45	54.8	79.32	1.152	26.51	109.5	0.05724	0.2217
50	60.2	78.72	1.263	28.15	110.2	0.06044	0.2214
55	65.9	78.11	1.382	29.80	110.9	0.06362	0.2212
60	72.2	77.50	1.510	31.45	111.5	0.06680	0.2209
65	78.8	76.87	1.647	33.12	112.2	0.06996	0.2206
70	85.8	76.24	1.795	34.80	112.8	0.07311	0.2204
75	93.5	75.59	1.953	36.49	113.4	0.07626	0.2201
80	101.4	74.94	2.123	38.20	114.0	0.07939	0.2199
85	109.9	74.27	2.305	39.91	114.6	0.08252	0.2197
90	119.0	73.58	2.501	41.65	115.2	0.08565	0.2194
95	128.6	72.88	2.710	43.39	115.7	0.08877	0.2192
100	138.9	72.17	2.935	45.15	116.3	0.09188	0.2190
105	149.7	71.44	3.176	46.93	116.8	0.09500	0.2187
110	161.1	70.69	3.435	48.73	117.3	0.09811	0.2185
115	173.1	69.93	3.713	50.55	117.8	0.1012	0.2183
120	185.9	69.14	4.012	52.38	118.3	0.1044	0.2180
125	199.3	68.32	4.333	54.24	118.7	0.1075	0.2177
130	213.4	67.49	4.679	56.12	119.1	0.1106	0.2174
135	228.3	66.62	5.052	58.02	119.5	0.1138	0.2171
140	243.9	65.73	5.455	59.95	119.8	0.1169	0.2167
145	260.4	64.80	5.892	61.92	120.1	0.1201	0.2163
150	277.6	63.83	6.366	63.91	120.4	0.1233	0.2159
155	295.7	62.82	6.882	65.94	120.6	0.1265	0.2154
160	314.7	61.76	7.447	68.00	120.7	0.1298	0.2149

Physical Properties of Refrigerants	R-401A	R-401B
Environmental Classification	HCFC	HCFC
Molecular Weight	94.4	92.8
Boiling Point (1 atm, F)	-29.9	-32.3
Critical Pressure (psia)	669	679.1
Critical Temperature (F)	221	218.3
Critical Density (lb./ft ³)	30.9	31.1
Liquid Density (70 F, lb./ft ³)	74.6	74.6
Vapor Density (bp, lb./ft ³)	0.306	0.303
Heat of Vaporization (bp, BTU/lb.)	97.5	98.2
Specific Heat Liquid (70 F, BTU/lb. F)	0.3037	0.3027
Specific Heat Vapor (1 atm, 70 F, BTU/lb. F)	0.1755	0.1725
Ozone Depletion Potential (CFC 11 = 1.0)	0.037	0.039
Global Warming Potential (CO ₂ = 1.0)	1163	1267
ASHRAE Standard 34 Safety Rating	A1	A1
Temperature Glide (F) (see section II)	8	8

Available in the following sizes:

R-401A

30R401A 30 lb cylinder
125R401A 125 lb cylinder*
1700R401A 1 ton cylinder*

R-401B

30R401B 30 lb cylinder
125R401B 125 lb cylinder*

*Deposit Required

**R-401A (R-22/152a/124)
(53 / 13 / 34 wt%)**

A blend of R-22, R-152a and R-124 intended for retrofitting R-12 systems. The pressure and system capacity match R-12 when the blend is running an average evaporator temperature of 10F to 20F.

Applications: direct expansion refrigeration, R-12 air conditioning, R-500 systems.

Retrofitting: for R-12 page 88
for R-500 page 91

**R-401B (R-22/152a/124)
(61 / 11 / 28 wt%)**

Similar to R-401A except higher in R-22 content. This blend has higher capacity at lower temperatures (matches R-12 at -20F), and also provides a closer match to R-500 at air conditioning temperatures.

Applications: Lower temperature R-12 refrigeration, transport refrigeration, R-12 and R-500 direct expansion air conditioning.

Retrofitting: for R-12 page 88
for R-500 page 91

Pressure-Temp Chart

Temp (F)	R-401A		R-401B	
	Liquid (psig)	Vapor (psig)	Liquid (psig)	Vapor (psig)
-40	8.1	13.2	6.5	11.8
-35	5.1	10.7	3.3	9.1
-30	1.7	7.9	0.2	6.1
-25	1.0	4.8	2.1	2.8
-20	3.0	1.4	4.3	0.5
-15	5.2	1.2	6.6	2.5
-10	7.7	3.3	9.2	4.7
-5	10.3	5.5	12.0	7.1
0	13.2	8.0	15.1	9.7
5	16.3	10.7	18.4	12.6
10	19.7	13.7	22.0	15.8
15	23.4	16.9	25.9	19.2
20	27.4	20.4	30.1	23.0
25	31.7	24.2	34.6	27.0
30	36.4	28.3	39.5	31.4
35	41.3	32.8	44.8	36.1
40	46.6	37.6	50.4	41.1
45	52.4	42.7	56.4	46.6
50	58.5	48.2	62.8	52.4
55	65.0	54.1	69.6	58.7
60	71.9	60.4	76.9	65.4
65	79.3	67.2	84.7	72.5
70	87.1	74.4	92.9	80.1
75	95.4	82.1	102	88.2
80	104	90.2	111	96.8
85	114	98.9	121	106
90	123	108	131	116
95	134	118	142	126
100	145	128	153	137
105	156	139	166	148
110	169	151	178	160
115	181	163	192	173
120	195	176	206	187
125	209	189	220	201
130	224	203	236	216
135	239	218	252	231
140	255	234	269	248
145	272	250	287	265
150	290	267	305	283

THERMODYNAMIC PROPERTIES OF R-401A

Temp [F]	Pressure	Pressure	Density	Density	Enthalpy	Enthalpy	Entropy	Entropy
	Liquid [psia]	Vapor [psia]	Liquid [lb/ft ³]	Vapor [lb/ft ³]	Liquid [Btu/lb]	Vapor [Btu/lb]	Liquid [Btu/R-lb]	Vapor [Btu/R-lb]
-60	6.5	4.7	88.18	0.1049	-5.371	94.93	-0.01309	0.2418
-55	7.5	5.5	87.71	0.1215	-4.035	95.60	-0.00977	0.2402
-50	8.7	6.4	87.24	0.1401	-2.694	96.26	-0.00648	0.2386
-45	9.9	7.4	86.77	0.1610	-1.350	96.93	-0.00323	0.2372
-40	11.4	8.6	86.29	0.1842	0.000	97.59	0.00000	0.2358
-35	12.9	9.9	85.82	0.2101	1.354	98.25	0.00320	0.2345
-30	14.7	11.3	85.33	0.2386	2.714	98.91	0.00637	0.2333
-25	16.6	12.9	84.85	0.2701	4.078	99.56	0.00952	0.2321
-20	18.7	14.7	84.36	0.3048	5.449	100.2	0.01265	0.2310
-15	21.0	16.6	83.86	0.3429	6.825	100.9	0.01575	0.2299
-10	23.6	18.8	83.37	0.3846	8.207	101.5	0.01882	0.2289
-5	26.4	21.2	82.86	0.4302	9.595	102.1	0.02188	0.2279
0	29.4	23.8	82.36	0.4799	10.99	102.8	0.02492	0.2269
5	32.7	26.6	81.84	0.5340	12.39	103.4	0.02793	0.2261
10	36.2	29.7	81.33	0.5927	13.80	104.0	0.03093	0.2252
15	40.1	33.1	80.80	0.6563	15.21	104.6	0.03391	0.2244
20	44.2	36.7	80.27	0.7251	16.64	105.2	0.03687	0.2236
25	48.7	40.7	79.74	0.7995	18.07	105.8	0.03982	0.2229
30	53.5	45.0	79.20	0.8798	19.51	106.4	0.04275	0.2221
35	58.6	49.6	78.65	0.9662	20.95	107.0	0.04566	0.2214
40	64.2	54.6	78.10	1.059	22.41	107.6	0.04857	0.2208
45	70.1	59.9	77.54	1.159	23.88	108.2	0.05145	0.2201
50	76.4	65.6	76.97	1.267	25.35	108.7	0.05433	0.2195
55	83.1	71.8	76.39	1.382	26.83	109.3	0.05720	0.2189
60	90.2	78.3	75.81	1.505	28.33	109.8	0.06005	0.2183
65	97.8	85.3	75.21	1.637	29.83	110.4	0.06290	0.2178
70	105.9	92.8	74.61	1.779	31.35	110.9	0.06573	0.2172
75	114.5	100.7	74.00	1.930	32.87	111.4	0.06856	0.2167
80	123.5	109.2	73.37	2.092	34.41	111.9	0.07138	0.2162
85	133.1	118.1	72.74	2.265	35.96	112.4	0.07420	0.2156
90	143.2	127.6	72.09	2.449	37.52	112.8	0.07701	0.2151
95	153.9	137.7	71.43	2.647	39.10	113.3	0.07981	0.2146
100	165.2	148.3	70.76	2.858	40.69	113.7	0.08261	0.2141
105	177.0	159.6	70.08	3.083	42.30	114.1	0.08541	0.2136
110	189.5	171.4	69.38	3.324	43.92	114.5	0.08822	0.2131
115	202.6	183.9	68.66	3.581	45.56	114.9	0.09102	0.2126
120	216.3	197.1	67.93	3.857	47.21	115.2	0.09382	0.2120
125	230.7	211.0	67.17	4.152	48.89	115.6	0.09663	0.2115
130	245.8	225.6	66.40	4.468	50.58	115.9	0.09945	0.2110
135	261.7	240.9	65.60	4.807	52.30	116.2	0.1023	0.2104
140	278.2	257.1	64.77	5.171	54.04	116.4	0.1051	0.2098
145	295.5	274.0	63.92	5.564	55.81	116.6	0.1080	0.2092
150	313.6	291.7	63.04	5.987	57.61	116.8	0.1108	0.2085
155	332.6	310.3	62.12	6.444	59.43	116.9	0.1137	0.2078

THERMODYNAMIC PROPERTIES OF R-401B

Temp	Pressure Liquid	Pressure Vapor	Density Liquid	Density Vapor	Enthalpy Liquid	Enthalpy Vapor	Entropy Liquid	Entropy Vapor
[F]	[psia]	[psia]	[lb/ft ³]	[lb/ft ³]	[Btu/lb]	[Btu/lb]	[Btu/R-lb]	[Btu/R-lb]
-60	6.9	5.2	88.34	0.1145	-5.346	95.56	-0.01302	0.2430
-55	8.0	6.1	87.87	0.1324	-4.016	96.21	-0.00972	0.2414
-50	9.2	7.1	87.40	0.1524	-2.681	96.86	-0.00645	0.2398
-45	10.6	8.2	86.92	0.1748	-1.343	97.51	-0.00321	0.2383
-40	12.1	9.4	86.44	0.1997	0.000	98.16	0.00000	0.2369
-35	13.7	10.8	85.96	0.2273	1.348	98.80	0.00318	0.2355
-30	15.6	12.4	85.47	0.2577	2.701	99.44	0.00634	0.2343
-25	17.6	14.1	84.98	0.2914	4.059	100.1	0.00947	0.2330
-20	19.8	16.0	84.48	0.3283	5.422	100.7	0.01258	0.2318
-15	22.3	18.1	83.99	0.3688	6.791	101.3	0.01567	0.2307
-10	25.0	20.5	83.48	0.4131	8.166	102.0	0.01873	0.2296
-5	27.9	23.0	82.97	0.4614	9.548	102.6	0.02177	0.2286
0	31.1	25.8	82.46	0.514	10.94	103.2	0.02479	0.2276
5	34.5	28.9	81.94	0.5713	12.33	103.8	0.02779	0.2267
10	38.3	32.2	81.42	0.6333	13.73	104.4	0.03077	0.2258
15	42.3	35.8	80.89	0.7005	15.14	105.0	0.03374	0.2249
20	46.7	39.7	80.35	0.7732	16.56	105.6	0.03669	0.2241
25	51.4	43.9	79.81	0.8516	17.98	106.2	0.03962	0.2233
30	56.4	48.5	79.26	0.9362	19.42	106.7	0.04253	0.2225
35	61.8	53.4	78.71	1.027	20.86	107.3	0.04544	0.2218
40	67.6	58.7	78.15	1.125	22.31	107.8	0.04832	0.2211
45	73.8	64.4	77.58	1.23	23.76	108.4	0.05120	0.2204
50	80.4	70.5	77.00	1.343	25.23	108.9	0.05406	0.2197
55	87.5	77.0	76.42	1.464	26.71	109.5	0.05692	0.2190
60	95.0	84.0	75.82	1.594	28.20	110.0	0.05976	0.2184
65	102.9	91.4	75.22	1.732	29.70	110.5	0.06259	0.2178
70	111	99.3	74.61	1.881	31.21	111.0	0.06542	0.2172
75	120	108	73.99	2.039	32.73	111.4	0.06824	0.2166
80	130	117	73.36	2.209	34.26	111.9	0.07105	0.2160
85	140	126	72.71	2.39	35.81	112.4	0.07385	0.2154
90	150	136	72.06	2.584	37.37	112.8	0.07665	0.2149
95	162	147	71.39	2.791	38.94	113.2	0.07945	0.2143
100	173	158	70.70	3.012	40.53	113.6	0.08224	0.2137
105	186	170	70.01	3.248	42.13	114.0	0.08504	0.2131
110	199	182	69.29	3.501	43.75	114.3	0.08783	0.2126
115	212	195	68.56	3.771	45.39	114.7	0.09063	0.2120
120	227	209	67.81	4.06	47.05	115.0	0.09343	0.2114
125	242	224	67.04	4.369	48.72	115.3	0.09624	0.2108
130	258	239	66.25	4.701	50.42	115.5	0.09905	0.2102
135	274	255	65.44	5.058	52.14	115.8	0.1019	0.2095
140	291	272	64.59	5.441	53.88	116.0	0.1047	0.2089
145	309	290	63.72	5.854	55.66	116.1	0.1076	0.2082
150	328	309	62.81	6.3	57.46	116.3	0.1105	0.2074
155	348	328	61.87	6.783	59.30	116.3	0.1134	0.2067

Physical Properties of Refrigerants	R-402A	R-402B
Environmental Classification	HCFC	HCFC
Molecular Weight	101.6	94.7
Boiling Point (1 atm, F)	-56.5	-52.9
Critical Pressure (psia)	600	645
Critical Temperature (F)	168	180.7
Critical Density (lb./ft ³)	33.8	33.1
Liquid Density (70 F, lb./ft ³)	72.61	72.81
Vapor Density (bp, lb./ft ³)	0.356	0.328
Heat of Vaporization (bp, BTU/lb.)	83.58	90.42
Specific Heat Liquid (70 F, BTU/lb. F)	0.3254	0.317
Specific Heat Vapor (1 atm, 70 F, BTU/lb. F)	0.1811	0.1741
Ozone Depletion Potential (CFC 11 = 1.0)	0.019	0.03
Global Warming Potential (CO ₂ = 1.0)	2746	2379
ASHRAE Standard 34 Safety Rating	A1	A1
Temperature Glide (see section II)	2.5	2.5

Available in the following sizes:

R-402A
27R402A 27 lb cylinder
110R402A 110 lb cylinder*

R-402B
13R402B 13 lb cylinder

*Deposit Required

R-402A (R-125/290/22)
(60 / 2 / 38 wt%)

A blend of R-22 and R-125 with hydrocarbon R-290 (propane) added to improve mineral oil circulation. This blend is formulated to match R-502 evaporator pressures, yet it has higher discharge pressure than 502. Although the propane helps with oil return, it is still recommended that some mineral oil be replaced with alkylbenzene.

Applications: Low temperature (R-502) refrigeration

Retrofitting: for R-502 page 92

R-402B (R-125/290/22)
(38 / 2 / 60 wt%)

Similar to R-402A, but with less R-125 and more R-22. This blend will generate higher discharge temperatures, which makes it work particularly well in ice machines.

Applications: Ice machines (R-502)

Retrofitting: for R-502 page 92

Pressure-Temp Chart

Temp (F)	R402A (psig)	R402B (psig)
-40	6.3	3.6
-35	9.1	6.0
-30	12.1	9.0
-25	15.4	12.0
-20	18.9	15.4
-15	22.9	18.6
-10	27.1	22.6
-5	31.7	27.0
0	36.7	31.0
5	42.1	36.0
10	48.0	42.0
15	54.2	47.0
20	60.9	54.0
25	68.1	60.0
30	75.8	67.0
35	84.0	75.0
40	92.8	83.4
45	102	91.6
50	112	100
55	123	110
60	134	120
65	146	133
70	158	143
75	171	155
80	185	170
85	200	183
90	215	198
95	232	213
100	249	230
105	267	247
110	286	262
115	305	283
120	326	303
125	347	323
130	370	345
135	393	-
140	418	-
145	443	-
150	470	-

THERMODYNAMIC PROPERTIES OF R-402A

<u>Temp</u> [F]	<u>Pressure</u> Liquid [psia]	<u>Pressure</u> Vapor [psia]	<u>Density</u> Liquid [lb/ft ³]	<u>Density</u> Vapor [lb/ft ³]	<u>Enthalpy</u> Liquid [Btu/lb]	<u>Enthalpy</u> Vapor [Btu/lb]	<u>Entropy</u> Liquid [Btu/R-lb]	<u>Entropy</u> Vapor [Btu/R-lb]
-60	13.4	12.0	89.70	0.2946	-5.410	78.16	-0.01316	0.1968
-55	15.3	13.8	89.14	0.3355	-4.067	78.80	-0.00983	0.1958
-50	17.4	15.8	88.58	0.3807	-2.718	79.45	-0.00653	0.1948
-45	19.8	18.0	88.01	0.4305	-1.362	80.09	-0.00325	0.1939
-40	22.3	20.5	87.44	0.4854	0.000	80.73	0.00000	0.1931
-35	25.2	23.2	86.86	0.5455	1.369	81.37	0.00323	0.1923
-30	28.3	26.1	86.28	0.6113	2.746	82.00	0.00644	0.1915
-25	31.7	29.4	85.69	0.6832	4.130	82.62	0.00962	0.1908
-20	35.4	32.9	85.09	0.7615	5.522	83.24	0.01279	0.1901
-15	39.4	36.8	84.48	0.8467	6.923	83.85	0.01594	0.1895
-10	43.8	41.0	83.87	0.9392	8.331	84.46	0.01906	0.1889
-5	48.6	45.6	83.25	1.039	9.749	85.06	0.02218	0.1883
0	53.7	50.6	82.62	1.148	11.18	85.65	0.02527	0.1878
5	59.2	56.0	81.99	1.265	12.61	86.23	0.02835	0.1873
10	65.2	61.7	81.34	1.392	14.06	86.81	0.03142	0.1868
15	71.6	68.0	80.68	1.528	15.52	87.37	0.03448	0.1863
20	78.4	74.7	80.02	1.675	16.98	87.93	0.03752	0.1858
25	85.8	81.8	79.34	1.834	18.46	88.48	0.04055	0.1854
30	93.6	89.5	78.65	2.004	19.95	89.01	0.04357	0.1850
35	102.0	97.7	77.95	2.187	21.46	89.53	0.04659	0.1846
40	110.9	106.4	77.24	2.383	22.97	90.05	0.04959	0.1842
45	120.3	115.8	76.51	2.595	24.50	90.54	0.05259	0.1838
50	130.4	125.7	75.76	2.821	26.04	91.02	0.05559	0.1834
55	141.1	136.2	75.00	3.065	27.60	91.49	0.05858	0.1830
60	152.4	147.4	74.23	3.326	29.18	91.94	0.06157	0.1826
65	164.4	159.2	73.43	3.607	30.77	92.37	0.06456	0.1822
70	177.1	171.8	72.61	3.909	32.38	92.78	0.06755	0.1818
75	190.5	185.0	71.78	4.233	34.00	93.17	0.07054	0.1814
80	204.6	199.0	70.91	4.583	35.65	93.54	0.07354	0.1810
85	219.5	213.8	70.02	4.959	37.32	93.88	0.07654	0.1806
90	235.1	229.3	69.10	5.366	39.01	94.19	0.07956	0.1801
95	251.6	245.7	68.15	5.805	40.73	94.47	0.08259	0.1797
100	269.0	263.0	67.17	6.281	42.48	94.71	0.08564	0.1791
105	287.2	281.1	66.14	6.799	44.25	94.91	0.08871	0.1786
110	306.3	300.2	65.06	7.362	46.07	95.07	0.09181	0.1780
115	326.4	320.2	63.93	7.979	47.92	95.18	0.09494	0.1773
120	347.4	341.3	62.74	8.658	49.81	95.22	0.09812	0.1766
125	369.5	363.3	61.48	9.408	51.76	95.20	0.1013	0.1758
130	392.6	386.5	60.13	10.25	53.76	95.09	0.1046	0.1748
135	416.9	410.8	58.67	11.19	55.84	94.88	0.1080	0.1738
140	442.2	436.3	57.07	12.26	58.01	94.55	0.1115	0.1725

THERMODYNAMIC PROPERTIES OF R-402B

<u>Temp</u> [F]	<u>Pressure</u> Liquid [psia]	<u>Pressure</u> Vapor [psia]	<u>Density</u> Liquid [lb/ft ³]	<u>Density</u> Vapor [lb/ft ³]	<u>Enthalpy</u> Liquid [Btu/lb]	<u>Enthalpy</u> Vapor [Btu/lb]	<u>Entropy</u> Liquid [Btu/R-lb]	<u>Entropy</u> Vapor [Btu/R-lb]
-60	12.2	10.8	88.76	0.2454	-5.366	85.51	-0.01306	0.2154
-55	13.9	12.4	88.23	0.2798	-4.033	86.14	-0.00975	0.2141
-50	15.9	14.2	87.70	0.3178	-2.694	86.76	-0.00647	0.2129
-45	18.0	16.2	87.16	0.3598	-1.350	87.38	-0.00322	0.2117
-40	20.4	18.5	86.62	0.4061	0.000	87.99	0.00000	0.2106
-35	23.0	20.9	86.07	0.4568	1.356	88.61	0.00320	0.2095
-30	25.9	23.6	85.52	0.5124	2.719	89.21	0.00638	0.2085
-25	29.1	26.6	84.96	0.5731	4.089	89.81	0.00953	0.2075
-20	32.5	29.9	84.40	0.6392	5.466	90.40	0.01266	0.2066
-15	36.2	33.4	83.83	0.7112	6.850	90.99	0.01577	0.2057
-10	40.3	37.3	83.25	0.7894	8.242	91.57	0.01887	0.2049
-5	44.7	41.5	82.67	0.8742	9.643	92.15	0.02194	0.2041
0	49.5	46.1	82.08	0.9659	11.05	92.71	0.02500	0.2033
5	54.7	51.1	81.48	1.065	12.47	93.27	0.02804	0.2025
10	60.2	56.4	80.88	1.172	13.89	93.82	0.03107	0.2018
15	66.2	62.2	80.26	1.287	15.33	94.36	0.03408	0.2011
20	72.6	68.3	79.64	1.412	16.78	94.89	0.03708	0.2005
25	79.4	75.0	79.01	1.545	18.23	95.41	0.04006	0.1998
30	86.7	82.1	78.37	1.689	19.70	95.92	0.04304	0.1992
35	94.6	89.7	77.72	1.843	21.18	96.42	0.04600	0.1986
40	102.9	97.8	77.05	2.008	22.67	96.91	0.04896	0.1980
45	111.8	106.5	76.38	2.186	24.17	97.38	0.05191	0.1974
50	121.2	115.7	75.69	2.376	25.68	97.84	0.05485	0.1968
55	131.2	125.5	74.99	2.580	27.21	98.29	0.05778	0.1963
60	141.9	136.0	74.28	2.798	28.75	98.71	0.06071	0.1957
65	153.1	147.0	73.55	3.032	30.31	99.13	0.06364	0.1952
70	165.0	158.7	72.81	3.283	31.88	99.52	0.06657	0.1946
75	177.6	171.1	72.05	3.552	33.47	99.89	0.06949	0.1940
80	190.8	184.1	71.27	3.840	35.08	100.2	0.07242	0.1935
85	204.8	197.9	70.47	4.149	36.70	100.6	0.07535	0.1929
90	219.5	212.5	69.64	4.482	38.35	100.9	0.07828	0.1923
95	235.0	227.8	68.80	4.839	40.01	101.2	0.08123	0.1917
100	251.3	243.9	67.92	5.224	41.70	101.4	0.08418	0.1911
105	268.4	260.9	67.02	5.638	43.42	101.6	0.08715	0.1904
110	286.3	278.7	66.08	6.086	45.16	101.8	0.09013	0.1898
115	305.2	297.4	65.11	6.572	46.94	101.9	0.09314	0.1891
120	324.9	317.1	64.09	7.099	48.74	102.0	0.09617	0.1883
125	345.6	337.7	63.03	7.674	50.59	102.1	0.09924	0.1875
130	367.3	359.3	61.91	8.303	52.48	102.1	0.1024	0.1866
135	390.0	382.0	60.73	8.996	54.42	102.0	0.1055	0.1856
140	413.7	405.7	59.47	9.764	56.41	101.8	0.1087	0.1846

Physical Properties of Refrigerants	R-403B
Environmental Classification	HCFC
Molecular Weight	103.25
Boiling Point (1 atm, F)	-46.8
Critical Pressure (psia)	637.7
Critical Temperature (F)	191.6
Critical Density (lb./ft ³)	32.9
Liquid Density (70 F, lb./ft ³)	72.8
Vapor Density (bp, lb./ft ³)	0.35
Heat of Vaporization (bp, BTU/lb.)	82.1
Specific Heat Liquid (70 F, BTU/lb. F)	0.313
Specific Heat Vapor (1 atm, 70 F, BTU/lb. F)	0.182
Ozone Depletion Potential (CFC 11 = 1.0)	0.028
Global Warming Potential (CO ₂ = 1.0)	4386
ASHRAE Standard 34 Safety Rating	A1
Temperature Glide (F) (see section II)	2

Available in the following sizes:

R-403B

30R403B 30 lb cylinder
 125R403B 125 lb cylinder*
 875R403B ½ ton cylinder*
 1750R403B ton cylinder*

*Deposit Required

R-403B (R-22/290/218)
 (56 / 5 / 39 wt%)

A blend of R-22 and R-218 with hydrocarbon R-290 (propane) added to improve oil circulation. This product was originally developed as a replacement for R-502, however it has come to be used as an alternative for R-13B1 in single stage, low-temperature systems. The evaporator will operate in a vacuum when the low side temperature is below -55F. When existing 13B1 systems are retrofitted to R-403B the capillary tube must be replaced with a longer/more restrictive size.

Applications: Very low temperature refrigeration (single stage, 13B1)

Retrofitting: for 13B1 page (to be added)

Pressure-Temp Chart

Temp (F)	R403B (psig)
-70	10.5"
-65	7.8"
-60	4.5"
-55	1.2"
-50	1.3
-45	3.3
-40	4.8
-35	7.4
-30	10.1
-25	13.2
-20	16.5
-15	20.1
-10	24.0
-5	28.2
0	32.8
5	37.7
10	43.0
15	48.7
20	54.9
25	61.4
30	68.4
35	75.9
40	84.8
45	93.3
50	102
55	112
60	122
65	132
70	144
75	156
80	168
85	181
90	195
95	210
100	225
105	242
110	258
115	276
120	295

THERMODYNAMIC PROPERTIES OF R-403B

<u>Temp</u> [F]	<u>Pressure</u> Liquid [psia]	<u>Pressure</u> Vapor [psia]	<u>Density</u> Liquid [lb/ft ³]	<u>Density</u> Vapor [lb/ft ³]	<u>Enthalpy</u> Liquid [Btu/lb]	<u>Enthalpy</u> Vapor [Btu/lb]	<u>Entropy</u> Liquid [Btu/R-lb]	<u>Entropy</u> Vapor [Btu/R-lb]
-70	9.7	9.4	88.22					
-65	11.0	10.8	87.65					
-60	12.6	12.3	87.07					
-55	14.2	14.0	86.50					
-50	16.1	15.8	85.92					
-45	18.1	17.8	85.35					
-40	20.2	19.5	84.77	0.470	4.23	82.89	0.02197	0.2087
-35	22.8	22.1	84.23	0.527	5.52	83.54	0.02501	0.2080
-30	25.6	24.8	83.69	0.590	6.83	84.18	0.02804	0.2073
-25	28.6	27.9	83.14	0.658	8.14	84.82	0.03105	0.2067
-20	32.0	31.2	82.58	0.731	9.46	85.46	0.03405	0.2062
-15	35.6	34.8	82.02	0.812	10.79	86.08	0.03703	0.2056
-10	39.5	38.7	81.45	0.898	12.13	86.70	0.03999	0.2051
-5	43.8	42.9	80.87	0.992	13.48	87.31	0.04294	0.2046
0	48.4	47.5	80.29	1.094	14.83	87.91	0.04587	0.2042
5	53.3	52.4	79.70	1.203	16.20	88.51	0.04880	0.2037
10	58.6	57.7	79.10	1.321	17.58	89.09	0.05171	0.2033
15	64.4	63.4	78.49	1.448	18.96	89.66	0.05460	0.2029
20	70.5	69.6	77.87	1.584	20.36	90.22	0.05749	0.2025
25	77.1	76.1	77.25	1.730	21.76	90.78	0.06036	0.2021
30	84.1	83.1	76.61	1.888	23.18	91.31	0.06322	0.2018
35	91.6	90.6	75.96	2.056	24.61	91.84	0.06608	0.2014
40	99.5	98.5	75.30	2.237	26.04	92.35	0.06892	0.2011
45	108.0	107.0	74.63	2.431	27.49	92.85	0.07176	0.2007
50	117.0	116.0	73.94	2.638	28.95	93.33	0.07458	0.2004
55	126.6	125.5	73.24	2.860	30.43	93.80	0.07740	0.2000
60	136.7	135.6	72.53	3.098	31.91	94.25	0.08022	0.1997
65	147.4	146.3	71.80	3.352	33.41	94.68	0.09303	0.1993
70	158.7	157.6	71.06	3.624	34.92	95.09	0.08583	0.1990
75	170.6	169.5	70.29	3.915	36.45	95.48	0.08863	0.1986
80	183.2	182.1	69.51	4.227	37.99	95.85	0.09143	0.1982
85	196.4	195.3	68.71	4.560	39.55	96.20	0.09423	0.1978
90	210.4	209.2	67.89	4.918	41.12	96.53	0.09702	0.1974
95	225.0	223.9	67.05	5.301	42.71	96.83	0.09982	0.1970
100	240.4	239.2	66.18	5.711	44.32	97.10	0.1026	0.1966
105	256.5	255.3	65.29	6.153	45.94	97.34	0.1054	0.1961
110	273.4	272.2	64.37	6.627	47.59	97.55	0.1082	0.1956
115	291.0	289.9	63.41	7.138	49.26	97.73	0.1111	0.1951
120	309.5	308.3	62.43	7.689	50.95	97.87	0.1139	0.1946

Physical Properties of Refrigerants	R-404A
Environmental Classification	HFC
Molecular Weight	97.6
Boiling Point (1 atm, F)	-51.8
Critical Pressure (psia)	548.2
Critical Temperature (F)	162.5
Critical Density (lb./ft ³)	35.84
Liquid Density (70 F, lb./ft ³)	66.37
Vapor Density (bp, lb./ft ³)	0.342
Heat of Vaporization (bp, BTU/lb.)	86.1
Specific Heat Liquid (70 F, BTU/lb. F)	0.3600
Specific Heat Vapor (1 atm, 70 F, BTU/lb. F)	0.2077
Ozone Depletion Potential (CFC 11 = 1.0)	0
Global Warming Potential (CO ₂ = 1.0)	3859
ASHRAE Standard 34 Safety Rating	A1
Temperature Glide (F) (see section II)	1.5

Available in the following sizes:

R-404A

24R404A 24 lb cylinder
100R404A 100 lb cylinder*
1300R404A ton cylinder*

*Deposit Required

R-404A (R-125/143a/134a)
(44 / 52 / 4 wt%)

A blend of R-125, R-143a and R-134a intended for low and medium temperature refrigeration. Most new equipment has been built for R-404A (and R-507 interchangeably). It is also possible to retrofit R-502 and R-22 systems with R-404A, although the oil will need to be flushed and replaced with Polyol Ester (POE). POE oils will be found in all new equipment intended for R-404A.

Applications: Low temperature refrigeration, medium temperature refrigeration, ice machines

Retrofitting: for R-502 page (to be added)
for R-22 page (to be added)

Pressure-Temp Chart

Temp (F)	R404A (psig)
-40	4.3
-35	6.8
-30	9.5
-25	12.5
-20	15.7
-15	19.3
-10	23.2
-5	27.5
0	32.1
5	37.0
10	42.4
15	48.2
20	54.5
25	61.2
30	68.4
35	76.1
40	84.4
45	93.2
50	103
55	113
60	123
65	135
70	147
75	159
80	173
85	187
90	202
95	218
100	234
105	252
110	270
115	289
120	310
125	331
130	353
135	377
140	401

THERMODYNAMIC PROPERTIES OF R-404A

Temp [F]	Pressure		Density		Enthalpy		Entropy	
	Liquid [psia]	Vapor [psia]	Liquid [lb/ft ³]	Vapor [lb/ft ³]	Liquid [Btu/lb]	Vapor [Btu/lb]	Liquid [Btu/R-lb]	Vapor [Btu/R-lb]
-60	11.8	11.3	82.53	0.2671	-5.913	81.19	-0.01439	0.2041
-55	13.5	13.0	82.01	0.3044	-4.447	81.92	-0.01075	0.2032
-50	15.4	14.9	81.48	0.3457	-2.973	82.64	-0.00714	0.2023
-45	17.6	16.9	80.94	0.3913	-1.490	83.36	-0.00356	0.2015
-40	19.9	19.3	80.40	0.4414	0.000	84.08	0.00000	0.2008
-35	22.5	21.8	79.86	0.4965	1.499	84.79	0.00354	0.2001
-30	25.4	24.6	79.31	0.5568	3.007	85.50	0.00705	0.1994
-25	28.5	27.7	78.75	0.6228	4.524	86.20	0.01054	0.1988
-20	31.9	31.0	78.19	0.6947	6.051	86.90	0.01402	0.1982
-15	35.6	34.7	77.62	0.7730	7.587	87.59	0.01747	0.1977
-10	39.7	38.7	77.05	0.8582	9.133	88.28	0.02091	0.1972
-5	44.1	43.0	76.46	0.9506	10.69	88.95	0.02433	0.1967
0	48.8	47.7	75.87	1.051	12.26	89.62	0.02773	0.1963
5	54.0	52.8	75.27	1.159	13.84	90.29	0.03112	0.1959
10	59.5	58.3	74.66	1.276	15.43	90.94	0.03449	0.1955
15	65.5	64.2	74.05	1.403	17.03	91.58	0.03785	0.1951
20	71.9	70.5	73.42	1.539	18.64	92.21	0.04120	0.1948
25	78.7	77.3	72.78	1.686	20.27	92.83	0.04454	0.1945
30	86.1	84.6	72.13	1.845	21.91	93.44	0.04787	0.1941
35	93.9	92.4	71.46	2.016	23.57	94.04	0.05120	0.1938
40	102.3	100.7	70.79	2.200	25.24	94.62	0.05451	0.1935
45	111.2	109.5	70.10	2.397	26.92	95.19	0.05782	0.1932
50	120.7	118.9	69.39	2.610	28.62	95.74	0.06113	0.1930
55	130.7	128.9	68.67	2.839	30.34	96.28	0.06443	0.1927
60	141.4	139.6	67.93	3.086	32.08	96.80	0.06774	0.1924
65	152.8	150.8	67.16	3.352	33.84	97.29	0.07104	0.1921
70	164.7	162.8	66.38	3.638	35.62	97.76	0.07435	0.1918
75	177.4	175.4	65.58	3.947	37.42	98.21	0.07767	0.1915
80	190.8	188.8	64.75	4.281	39.24	98.63	0.08099	0.1911
85	204.9	202.8	63.89	4.642	41.09	99.03	0.08433	0.1908
90	219.9	217.7	62.99	5.033	42.97	99.39	0.08768	0.1904
95	235.6	233.4	62.07	5.458	44.87	99.71	0.09105	0.1900
100	252.1	249.9	61.10	5.921	46.81	100.0	0.09444	0.1895
105	269.5	267.3	60.09	6.426	48.79	100.2	0.09786	0.1890
110	287.8	285.5	59.03	6.981	50.81	100.4	0.1013	0.1884
115	307.0	304.7	57.91	7.592	52.88	100.5	0.1048	0.1878
120	327.2	324.9	56.73	8.271	54.99	100.6	0.1084	0.1870
125	348.4	346.1	55.46	9.029	57.18	100.5	0.1120	0.1862
130	370.6	368.4	54.08	9.886	59.43	100.4	0.1157	0.1852
135	394.0	391.8	52.58	10.87	61.79	100.1	0.1196	0.1840
140	418.5	416.4	50.92	12.01	64.26	99.60	0.1236	0.1825
145	444.3	442.3	49.01	13.39	66.9	98.89	0.1278	0.1807
150	471.4	469.6	46.73	15.13	69.81	97.78	0.1324	0.1783
155	500.0	498.4	43.74	17.55	73.21	95.98	0.1378	0.1748

Physical Properties of Refrigerants	R-407C
Environmental Classification	HFC
Molecular Weight	86.2
Boiling Point (1 atm, F)	-43.6
Critical Pressure (psia)	672.1
Critical Temperature (F)	187
Critical Density (lb./ft ³)	32
Liquid Density (70 F, lb./ft ³)	72.35
Vapor Density (bp, lb./ft ³)	0.289
Heat of Vaporization (bp, BTU/lb.)	106.7
Specific Heat Liquid (70 F, BTU/lb. F)	0.3597
Specific Heat Vapor (1 atm, 70 F, BTU/lb. F)	0.1987
Ozone Depletion Potential (CFC 11 = 1.0)	0
Global Warming Potential (CO ₂ = 1.0)	1674
ASHRAE Standard 34 Safety Rating	A1
Temperature Glide (F) (see section II)	10

Available in the following sizes:

R-407C

25R407C 25 lb cylinder
115R407C 115 lb cylinder*

*Deposit Required

R-407C (R-32/125/134a)
(23 / 25 / 52 wt%)

A blend of R-32, R-125 and R-134a that has very similar properties to R-22 in air conditioning equipment. There is a slight decrease in capacity and efficiency, however R-407C can be used in essentially the same equipment to perform the same job with only minor engineering modifications. New systems built with R-407C must have POE lubricants, and retrofitted R-22 systems would need the residual oil flushed with POE. R-407C has a 10F temperature glide, which should not pose any operation-related problems for a typical system.

Applications: Air conditioning, higher temperature refrigeration

Retrofitting: for R-22 page 90

Pressure-Temp Chart

R-407C		
Temp (F)	Liquid (psig)	Vapor (psig)
-40	3.0	4.4
-35	5.4	0.6
-30	8.0	1.8
-25	10.9	4.1
-20	14.1	6.6
-15	17.6	9.4
-10	21.3	12.5
-5	25.4	15.9
0	29.9	19.6
5	34.7	23.6
10	39.9	28.0
15	45.6	32.8
20	51.6	38.0
25	58.2	43.6
30	65.2	49.6
35	72.6	56.1
40	80.7	63.1
45	89.2	70.6
50	98.3	78.7
55	108	87.3
60	118	96.8
65	129	106
70	141	117
75	153	128
80	166	140
85	180	153
90	195	166
95	210	181
100	226	196
105	243	211
110	261	229
115	280	247
120	300	266
125	321	286
130	342	307
135	365	329
140	389	353

THERMODYNAMIC PROPERTIES OF R-407C

<u>Temp</u> [F]	<u>Pressure</u> Liquid [psia]	<u>Pressure</u> Vapor [psia]	<u>Density</u> Liquid [lb/ft ³]	<u>Density</u> Vapor [lb/ft ³]	<u>Enthalpy</u> Liquid [Btu/lb]	<u>Enthalpy</u> Vapor [Btu/lb]	<u>Entropy</u> Liquid [Btu/R-lb]	<u>Entropy</u> Vapor [Btu/R-lb]
-60	10.2	6.9	87.66	0.1418	-6.192	100.9	-0.01508	0.2575
-55	11.8	8.0	87.14	0.1641	-4.653	101.6	-0.01126	0.2558
-50	13.5	9.4	86.61	0.1890	-3.108	102.3	-0.00747	0.2542
-45	15.4	10.8	86.08	0.2169	-1.557	103.0	-0.00372	0.2527
-40	17.6	12.5	85.55	0.2480	0.000	103.7	0.00000	0.2512
-35	19.9	14.3	85.01	0.2825	1.564	104.4	0.00369	0.2498
-30	22.6	16.4	84.46	0.3206	3.134	105.1	0.00735	0.2484
-25	25.4	18.7	83.91	0.3628	4.711	105.8	0.01099	0.2472
-20	28.6	21.2	83.36	0.4092	6.296	106.5	0.01460	0.2459
-15	32.0	24.0	82.80	0.4602	7.888	107.2	0.01818	0.2448
-10	35.8	27.1	82.23	0.5160	9.488	107.9	0.02174	0.2437
-5	39.9	30.5	81.66	0.5771	11.10	108.5	0.02528	0.2426
0	44.3	34.2	81.08	0.6438	12.71	109.2	0.02879	0.2416
5	49.1	38.3	80.50	0.7164	14.34	109.8	0.03229	0.2406
10	54.3	42.7	79.90	0.7954	15.97	110.5	0.03576	0.2396
15	59.9	47.4	79.30	0.8812	17.62	111.1	0.03922	0.2387
20	66.0	52.6	78.70	0.9742	19.27	111.7	0.04265	0.2378
25	72.5	58.3	78.08	1.075	20.94	112.3	0.04608	0.2370
30	79.4	64.3	77.46	1.184	22.62	112.9	0.04948	0.2361
35	86.9	70.9	76.82	1.302	24.30	113.5	0.05288	0.2353
40	94.9	77.9	76.18	1.429	26.00	114.1	0.05626	0.2346
45	103.4	85.4	75.52	1.566	27.72	114.6	0.05963	0.2338
50	112.5	93.5	74.85	1.714	29.44	115.1	0.06298	0.2331
55	122.2	102.2	74.18	1.873	31.18	115.7	0.06633	0.2323
60	132.4	111.5	73.48	2.044	32.94	116.2	0.06968	0.2316
65	143.4	121.4	72.78	2.229	34.71	116.7	0.07301	0.2309
70	154.9	131.9	72.06	2.428	36.49	117.1	0.07635	0.2302
75	167.2	143.1	71.32	2.642	38.30	117.6	0.07968	0.2295
80	180.2	155.1	70.57	2.872	40.12	118.0	0.08301	0.2288
85	193.8	167.7	69.80	3.120	41.96	118.4	0.08634	0.2281
90	208.3	181.2	69.00	3.387	43.82	118.8	0.08967	0.2274
95	223.5	195.4	68.19	3.675	45.71	119.1	0.09301	0.2266
100	239.6	210.5	67.35	3.985	47.62	119.4	0.09636	0.2259
105	256.5	226.5	66.48	4.321	49.55	119.7	0.09972	0.2251
110	274.3	243.4	65.59	4.684	51.52	120.0	0.1031	0.2243
115	292.9	261.2	64.66	5.078	53.51	120.2	0.1065	0.2235
120	312.5	280.0	63.70	5.505	55.54	120.3	0.1099	0.2226
125	333.0	299.9	62.70	5.971	57.60	120.4	0.1133	0.2217
130	354.6	320.8	61.65	6.479	59.71	120.5	0.1168	0.2208
135	377.1	342.9	60.55	7.037	61.86	120.5	0.1203	0.2197
140	400.7	366.1	59.39	7.652	64.06	120.4	0.1239	0.2186

Physical Properties of Refrigerants	R-408A
Environmental Classification	HCFC
Molecular Weight	87
Boiling Point (1 atm, F)	-49.8
Critical Pressure (psia)	641.6
Critical Temperature (F)	182
Critical Density (lb./ft ³)	30
Liquid Density (70 F, lb./ft ³)	66.9
Vapor Density (bp, lb./ft ³)	0.303
Heat of Vaporization (bp, BTU/lb.)	96.74
Specific Heat Liquid (70 F, BTU/lb. F)	0.3416
Specific Heat Vapor (1 atm, 70 F, BTU/lb. F)	0.1901
Ozone Depletion Potential (CFC 11 = 1.0)	0.024
Global Warming Potential (CO ₂ = 1.0)	3102
ASHRAE Standard 34 Safety Rating	A1
Temperature Glide (F) (see section II)	1.0

Available in the following sizes:

R-408A

24R408A 24 lb cylinder
100R408A 100 lb cylinder*

*Deposit Required

R-408A (R-125/143a/22)
(7 / 46 / 47 wt%)

A blend of R-22, R-143a and R-125, intended for retrofitting R-502 refrigeration systems. This blend has the closest pressure/temperature match to R-502 across the whole operating range of temperatures. Discharge temperature will increase compared to R-502, however in most applications this will not impact system performance or long term reliability. In severe duty applications, such as transport refrigeration into hot climates, the OEM may not recommend this blend.

Applications: Low temperature and medium temperature refrigeration

Retrofitting: for R-502 page 92

Pressure-Temp Chart

Temp (F)	R408A (psig)
-40	2.8
-35	5.1
-30	7.6
-25	10.4
-20	13.5
-15	16.8
-10	20.4
-5	24.4
0	28.7
5	33.3
10	38.3
15	43.7
20	49.5
25	55.8
30	62.5
35	69.7
40	77.4
45	85.6
50	94.3
55	104
60	114
65	124
70	135
75	147
80	159
85	173
90	186
95	201
100	217
105	233
110	250
115	268
120	287
125	307
130	327
135	349
140	372

THERMODYNAMIC PROPERTIES OF R-408A

<u>Temp</u> [F]	<u>Pressure</u> Liquid [psia]	<u>Pressure</u> Vapor [psia]	<u>Density</u> Liquid [lb/ft ³]	<u>Density</u> Vapor [lb/ft ³]	<u>Enthalpy</u> Liquid [Btu/lb]	<u>Enthalpy</u> Vapor [Btu/lb]	<u>Entropy</u> Liquid [Btu/R-lb]	<u>Entropy</u> Vapor [Btu/R-lb]
-60	11.2	10.9	81.70	0.2288	-5.734	92.47	-0.01396	0.2320
-55	12.8	12.5	81.21	0.2604	-4.311	93.14	-0.01043	0.2306
-50	14.6	14.3	80.72	0.2954	-2.881	93.79	-0.00692	0.2293
-45	16.7	16.3	80.22	0.3339	-1.444	94.45	-0.00345	0.2280
-40	18.9	18.5	79.72	0.3763	0.000	95.10	0.00000	0.2268
-35	21.4	21.0	79.21	0.4228	1.451	95.74	0.00342	0.2257
-30	24.1	23.7	78.70	0.4736	2.910	96.38	0.00682	0.2246
-25	27.1	26.6	78.18	0.5291	4.376	97.01	0.01020	0.2235
-20	30.3	29.8	77.65	0.5896	5.851	97.64	0.01356	0.2225
-15	33.9	33.3	77.13	0.6554	7.334	98.26	0.01689	0.2215
-10	37.7	37.1	76.59	0.7268	8.826	98.87	0.02021	0.2206
-5	41.9	41.3	76.05	0.8042	10.33	99.47	0.02350	0.2197
0	46.4	45.8	75.50	0.8879	11.84	100.1	0.02678	0.2189
5	51.3	50.7	74.95	0.9784	13.36	100.7	0.03005	0.2181
10	56.6	55.9	74.39	1.076	14.89	101.2	0.03329	0.2173
15	62.3	61.5	73.82	1.181	16.43	101.8	0.03653	0.2165
20	68.4	67.6	73.24	1.295	17.98	102.4	0.03975	0.2158
25	74.9	74.1	72.65	1.416	19.54	102.9	0.04295	0.2150
30	81.9	81.1	72.06	1.547	21.12	103.4	0.04615	0.2143
35	89.4	88.5	71.45	1.688	22.71	103.9	0.04934	0.2137
40	97.4	96.5	70.84	1.839	24.31	104.4	0.05251	0.2130
45	105.9	104.9	70.21	2.001	25.92	104.9	0.05568	0.2124
50	115.0	113.9	69.58	2.175	27.55	105.4	0.05885	0.2117
55	124.6	123.5	68.93	2.361	29.19	105.9	0.06200	0.2111
60	134.8	133.7	68.26	2.561	30.85	106.3	0.06516	0.2105
65	145.6	144.5	67.59	2.775	32.52	106.7	0.06831	0.2098
70	157.1	155.9	66.90	3.005	34.22	107.1	0.07146	0.2092
75	169.2	167.9	66.19	3.251	35.93	107.5	0.07461	0.2086
80	181.9	180.7	65.46	3.515	37.66	107.9	0.07776	0.2079
85	195.4	194.1	64.72	3.799	39.41	108.2	0.08092	0.2073
90	209.6	208.3	63.95	4.104	41.18	108.5	0.08409	0.2066
95	224.6	223.2	63.16	4.433	42.98	108.8	0.08726	0.2060
100	240.3	238.9	62.34	4.787	44.80	109.0	0.09045	0.2052
105	256.9	255.5	61.50	5.169	46.65	109.2	0.09365	0.2045
110	274.3	272.8	60.62	5.583	48.53	109.4	0.09688	0.2037
115	292.6	291.1	59.71	6.031	50.45	109.5	0.1001	0.2029
120	311.7	310.2	58.76	6.520	52.40	109.6	0.1034	0.2021
125	331.8	330.3	57.76	7.053	54.40	109.6	0.1067	0.2012
130	352.8	351.3	56.71	7.638	56.44	109.5	0.1101	0.2002
135	374.9	373.3	55.60	8.284	58.54	109.4	0.1135	0.1991
140	398.0	396.4	54.41	9.002	60.71	109.2	0.1170	0.1979

Physical Properties of Refrigerants	R-409A
Environmental Classification	HCFC
Molecular Weight	97.4
Boiling Point (1 atm, F)	-31.8
Critical Pressure (psia)	680.7
Critical Temperature (F)	224.4
Critical Density (lb./ft ³)	31.7
Liquid Density (70 F, lb./ft ³)	76.1
Vapor Density (bp, lb./ft ³)	0.313
Heat of Vaporization (bp, BTU/lb.)	94.75
Specific Heat Liquid (70 F, BTU/lb. F)	0.2908
Specific Heat Vapor (1 atm, 70 F, BTU/lb. F)	0.1685
Ozone Depletion Potential (CFC 11 = 1.0)	0.047
Global Warming Potential (CO ₂ = 1.0)	1558
ASHRAE Standard 34 Safety Rating	A1
Temperature Glide (F) (see section II)	13

Available in the following sizes:

R-409A

30R409A 30 lb cylinder
125R409A 125 lb cylinder*

*Deposit Required

R-409A (R-22/124/142b)
(60 / 25 / 15 wt%)

A blend of R-22, R-142b and R-124 intended for retrofitting R-12 and R-500 systems. The pressure and system capacity match R-12 when the blend is running in an average evaporator temperature at 10F to 20F. The temperature glide of this blend is around 13F. The discharge pressure and temperature are higher than with R-12, however this should not be a problem in most applications. In hotter environments where compressor failures have been a problem it would be recommended to use R-414B instead (similar blend, less R-22). R-409A also comes close to matching the properties of R-500 at air conditioning temperatures.

Applications: Low temperature and medium temperature refrigeration, non-centrifugal air conditioning (R-12 or R-500)

Retrofitting: for R-12 page 88
for R-500 page 91

Pressure-Temp Chart

Temp (F)	R-409A	
	Liquid (psig)	Vapor (psig)
-30	0.2	9.9
-25	1.8	7.0
-20	3.9	3.8
-15	6.2	0.3
-10	8.7	1.7
-5	11.4	3.8
0	14.4	6.1
5	17.6	8.6
10	21.1	11.4
15	24.9	14.4
20	29.0	17.6
25	33.4	21.2
30	38.1	25.0
35	43.2	29.2
40	48.6	33.6
45	54.4	38.5
50	60.6	43.6
55	67.2	49.2
60	74.2	55.2
65	81.7	61.5
70	89.6	68.4
75	98.0	75.6
80	107	83.4
85	116	91.6
90	126	100
95	137	110
100	148	120
105	159	130
110	172	141
115	184	153
120	198	165
125	212	178
130	227	192
135	242	207
140	258	222

THERMODYNAMIC PROPERTIES OF R-409A

Temp [F]	Pressure Liquid [psia]	Pressure Vapor [psia]	Density Liquid [lb/ft ³]	Density Vapor [lb/ft ³]	Enthalpy Liquid [Btu/lb]	Enthalpy Vapor [Btu/lb]	Entropy Liquid [Btu/R-lb]	Entropy Vapor [Btu/R-lb]
-40	11.9	8.0	87.87	0.1779	0.000	94.00	0.00000	0.2287
-35	13.6	9.3	87.38	0.2030	1.295	94.64	0.00306	0.2274
-30	15.4	10.6	86.90	0.2308	2.594	95.28	0.00609	0.2262
-25	17.4	12.1	86.41	0.2616	3.899	95.92	0.00910	0.2250
-20	19.5	13.8	85.92	0.2954	5.209	96.55	0.01209	0.2239
-15	21.9	15.7	85.42	0.3326	6.524	97.18	0.01505	0.2229
-10	24.6	17.7	84.92	0.3734	7.846	97.81	0.01799	0.2219
-5	27.4	20.0	84.41	0.4180	9.174	98.43	0.02092	0.2209
0	30.5	22.5	83.90	0.4666	10.51	99.05	0.02382	0.2200
5	33.9	25.2	83.38	0.5196	11.85	99.67	0.02670	0.2191
10	37.5	28.2	82.86	0.5771	13.20	100.3	0.02957	0.2182
15	41.5	31.4	82.34	0.6395	14.55	100.9	0.03242	0.2174
20	45.7	34.9	81.80	0.7070	15.91	101.5	0.03525	0.2167
25	50.3	38.7	81.26	0.7800	17.28	102.1	0.03807	0.2159
30	55.2	42.8	80.72	0.8588	18.66	102.6	0.04088	0.2152
35	60.5	47.3	80.17	0.9437	20.05	103.2	0.04367	0.2145
40	66.1	52.0	79.61	1.035	21.44	103.8	0.04645	0.2139
45	72.1	57.2	79.04	1.133	22.84	104.4	0.04921	0.2132
50	78.5	62.7	78.47	1.239	24.25	104.9	0.05197	0.2126
55	85.4	68.6	77.89	1.352	25.67	105.5	0.05471	0.2120
60	92.6	74.9	77.30	1.473	27.11	106.0	0.05744	0.2115
65	100.3	81.7	76.70	1.603	28.55	106.5	0.06017	0.2109
70	108.5	88.9	76.09	1.742	30.00	107.0	0.06288	0.2104
75	117.2	96.6	75.48	1.891	31.46	107.5	0.06559	0.2099
80	126.3	104.8	74.85	2.050	32.93	108.0	0.06829	0.2093
85	136.0	113.4	74.21	2.219	34.42	108.5	0.07098	0.2088
90	146.2	122.7	73.56	2.401	35.92	109.0	0.07367	0.2083
95	157.0	132.4	72.90	2.594	37.43	109.4	0.07636	0.2078
100	168.3	142.7	72.22	2.801	38.95	109.9	0.07904	0.2074
105	180.2	153.7	71.54	3.022	40.49	110.3	0.08172	0.2069
110	192.7	165.2	70.83	3.258	42.04	110.7	0.08440	0.2064
115	205.9	177.4	70.11	3.510	43.61	111.1	0.08708	0.2059
120	219.6	190.2	69.38	3.779	45.19	111.4	0.08977	0.2054
125	234.1	203.7	68.62	4.068	46.80	111.8	0.09245	0.2049
130	249.2	217.9	67.85	4.376	48.42	112.1	0.09515	0.2043
135	265.0	232.9	67.05	4.707	50.06	112.4	0.09785	0.2038
140	281.5	248.6	66.22	5.062	51.72	112.6	0.1006	0.2033
145	298.8	265.1	65.38	5.443	53.41	112.9	0.1033	0.2027
150	316.8	282.5	64.50	5.853	55.13	113.1	0.1060	0.2021
155	335.6	300.7	63.58	6.296	56.87	113.2	0.1088	0.2014
160	355.2	319.8	62.63	6.775	58.65	113.4	0.1116	0.2008

Physical Properties of Refrigerants	R-410A
Environmental Classification	HFC
Molecular Weight	72.6
Boiling Point (1 atm, F)	-61
Critical Pressure (psia)	691.8
Critical Temperature (F)	158.3
Critical Density (lb./ft ³)	34.5
Liquid Density (70 F, lb./ft ³)	67.74
Vapor Density (bp, lb./ft ³)	0.261
Heat of Vaporization (bp, BTU/lb.)	116.8
Specific Heat Liquid (70 F, BTU/lb. F)	0.3948
Specific Heat Vapor (1 atm, 70 F, BTU/lb. F)	0.1953
Ozone Depletion Potential (CFC 11 = 1.0)	0
Global Warming Potential (CO ₂ = 1.0)	1997
ASHRAE Standard 34 Safety Rating	A1
Temperature Glide (F) (see section II)	0.2

Available in the following sizes:

R-410A

25R410A 25 lb cylinder
100R410A 100 lb cylinder*
1450R410A ton cylinder*

*Deposit Required

R-410A (R-32/125)
(50 / 50 wt%)

A blend of R-32 and R-125 that nearly forms an azeotrope, and therefore has extremely low temperature glide and almost no fractionation potential. This blend has about 60% higher pressure than R-22 in air conditioning applications, and should be used only in new equipment that has been designed for the increased pressure (cannot be used to retrofit R-22 systems). R-410A will require the use of POE lubricants.

Applications: Air conditioning and heat pumps (new equipment only)

Retrofitting: not recommended

Pressure-Temp Chart

Temp (F)	R410A (psig)
-40	11.6
-35	14.9
-30	18.5
-25	22.5
-20	26.9
-15	31.7
-10	36.8
-5	42.5
0	48.6
5	55.2
10	62.3
15	70.0
20	78.3
25	87.3
30	96.8
35	107
40	118
45	130
50	142
55	155
60	170
65	185
70	201
75	217
80	235
85	254
90	274
95	295
100	317
105	340
110	365
115	391
120	418
125	446
130	476
135	507
140	539
145	573
150	608

THERMODYNAMIC PROPERTIES OF R-410A

Temp [F]	Pressure	Pressure	Density	Density	Enthalpy	Enthalpy	Entropy	Entropy
	Liquid [psia]	Vapor [psia]	Liquid [lb/ft ³]	Vapor [lb/ft ³]	Liquid [Btu/lb]	Vapor [Btu/lb]	Liquid [Btu/R-lb]	Vapor [Btu/R-lb]
-40	25.6	25.5	82.02	0.4384	0.000	112.5	0.00000	0.2682
-35	28.9	28.9	81.45	0.4929	1.648	113.1	0.00389	0.2664
-30	32.6	32.6	80.88	0.5526	3.303	113.7	0.00774	0.2647
-25	36.7	36.6	80.30	0.6179	4.967	114.3	0.01157	0.2631
-20	41.1	41.0	79.71	0.6892	6.640	114.8	0.01537	0.2615
-15	46.0	45.8	79.12	0.7669	8.321	115.4	0.01915	0.2599
-10	51.2	51.1	78.51	0.8514	10.01	115.9	0.02290	0.2584
-5	56.9	56.8	77.91	0.9431	11.71	116.4	0.02663	0.2570
0	63.1	63.0	77.29	1.043	13.42	116.9	0.03035	0.2555
5	69.8	69.7	76.66	1.151	15.15	117.4	0.03404	0.2541
10	77.1	76.9	76.03	1.267	16.88	117.9	0.03771	0.2528
15	84.9	84.6	75.38	1.394	18.63	118.3	0.04137	0.2514
20	93.2	93.0	74.73	1.530	20.39	118.8	0.04502	0.2501
25	102.2	101.9	74.06	1.677	22.16	119.2	0.04865	0.2488
30	111.9	111.5	73.38	1.836	23.95	119.6	0.05227	0.2476
35	122.2	121.8	72.69	2.007	25.75	119.9	0.05588	0.2463
40	133.2	132.8	71.99	2.192	27.58	120.3	0.05949	0.2451
45	144.9	144.5	71.27	2.391	29.41	120.6	0.06309	0.2438
50	157.4	156.9	70.53	2.606	31.27	120.9	0.06668	0.2426
55	170.7	170.2	69.78	2.838	33.14	121.2	0.07028	0.2413
60	184.8	184.3	69.01	3.088	35.04	121.4	0.07387	0.2401
65	199.8	199.2	68.22	3.357	36.96	121.6	0.07747	0.2388
70	215.7	215.1	67.41	3.648	38.90	121.8	0.08107	0.2376
75	232.5	231.8	66.58	3.963	40.87	121.9	0.08469	0.2363
80	250.3	249.6	65.71	4.304	42.87	122.0	0.08832	0.2350
85	269.1	268.3	64.82	4.674	44.90	122.0	0.09196	0.2336
90	289.0	288.2	63.90	5.075	46.96	122.0	0.09562	0.2322
95	310.0	309.1	62.95	5.513	49.06	122.0	0.09932	0.2308
100	332.0	331.1	61.95	5.990	51.21	121.8	0.1030	0.2293
105	355.3	354.3	60.90	6.513	53.39	121.6	0.1068	0.2277
110	379.8	378.8	59.81	7.089	55.63	121.4	0.1106	0.2261
115	405.6	404.5	58.65	7.725	57.93	121.0	0.1145	0.2243
120	432.7	431.6	57.42	8.434	60.30	120.5	0.1185	0.2224
125	461.2	460.1	56.11	9.230	62.76	119.9	0.1225	0.2203
130	491.2	490.1	54.68	10.13	65.31	119.2	0.1267	0.2180
135	522.7	521.6	53.12	11.17	67.99	118.2	0.1310	0.2155
140	555.9	554.8	51.38	12.40	70.84	117.0	0.1356	0.2125

Physical Properties of Refrigerants	R-414B
Environmental Classification	HCFC
Molecular Weight	101.6
Boiling Point (1 atm, F)	-29.9
Critical Pressure (psia)	665.4
Critical Temperature (F)	226.4
Critical Density (lb./ft ³)	31.6
Liquid Density (70 F, lb./ft ³)	76.02
Vapor Density (bp, lb./ft ³)	0.325
Heat of Vaporization (bp, BTU/lb.)	91.5
Specific Heat Liquid (70 F, BTU/lb. F)	0.2913
Specific Heat Vapor (1 atm, 70 F, BTU/lb. F)	0.1723
Ozone Depletion Potential (CFC 11 = 1.0)	0.043
Global Warming Potential (CO ₂ = 1.0)	1339
ASHRAE Standard 34 Safety Rating	A1
Temperature Glide (F) (see section II)	13

Available in the following sizes:

R-410A

25R414B 25 lb cylinder

R-414B (R-22/600a/124/142b)
(50 / 1.5 / 39 / 9.5 wt%)

A blend of R-22, R-124, R-142b and hydrocarbon R-600a (isobutane), which is added to improve mineral oil circulation. This is a multi-purpose retrofit blend that can be used in R-12 refrigeration systems as well as automotive air conditioning. The pressure and system capacity match R-12 in 30F to 40F evaporators, and the discharge pressure in hot condensers is only 5 to 10 psi higher than R-12 (a benefit in high ambient temperatures compared to other R-12 retrofit blends). The addition of hydrocarbon to this blend significantly improves mineral oil circulation for high viscosity oils used in auto AC.

Applications: Low temperature and medium temperature refrigeration, direct expansion air conditioning, automotive air conditioning

Retrofitting: for R-12 page 88

Pressure-Temp Chart

Temp (F)	R-414B	
	Liquid (psig)	Vapor (psig)
-30	0.0	9.7
-25	1.9	6.8
-20	4.0	3.6
-15	6.3	0.0
-10	8.8	2.0
-5	11.5	4.1
0	14.5	6.5
5	17.7	9.0
10	21.2	11.9
15	25.0	14.9
20	29.0	18.3
25	33.4	21.9
30	38.1	25.8
35	43.1	30.0
40	48.5	34.6
45	54.3	39.5
50	60.4	44.8
55	67.0	50.4
60	73.9	56.5
65	81.3	62.9
70	89.1	69.8
75	97.4	77.1
80	106	85.0
85	116	93.3
90	125	102
95	136	111
100	146	121
105	158	132
110	170	143
115	183	155
120	196	167
125	210	180
130	224	193
135	239	208
140	255	223
145	272	239
150	289	255

THERMODYNAMIC PROPERTIES OF R-414B

<u>Temp</u> [F]	<u>Pressure</u> Liquid [psia]	<u>Pressure</u> Vapor [psia]	<u>Density</u> Liquid [lb/ft ³]	<u>Density</u> Vapor [lb/ft ³]	<u>Enthalpy</u> Liquid [Btu/lb]	<u>Enthalpy</u> Vapor [Btu/lb]	<u>Entropy</u> Liquid [Btu/R-lb]	<u>Entropy</u> Vapor [Btu/R-lb]
-40	11.4	7.5	87.77	0.1727	0.000	90.85	0.00000	0.2212
-35	12.9	8.6	87.29	0.1973	1.298	91.51	0.00307	0.2200
-30	14.7	9.9	86.81	0.2247	2.601	92.17	0.00611	0.2189
-25	16.6	11.4	86.32	0.2549	3.909	92.83	0.00913	0.2179
-20	18.7	12.9	85.83	0.2883	5.222	93.48	0.01212	0.2169
-15	21.0	14.7	85.33	0.3250	6.542	94.13	0.01509	0.2159
-10	23.5	16.7	84.83	0.3652	7.867	94.78	0.01804	0.2151
-5	26.2	18.8	84.32	0.4093	9.198	95.43	0.02098	0.2142
0	29.2	21.2	83.81	0.4573	10.54	96.07	0.02389	0.2134
5	32.4	23.7	83.30	0.5097	11.88	96.71	0.02678	0.2127
10	35.9	26.6	82.78	0.5666	13.23	97.34	0.02966	0.2119
15	39.7	29.6	82.25	0.6284	14.59	97.97	0.03251	0.2112
20	43.7	33.0	81.72	0.6953	15.96	98.59	0.03536	0.2106
25	48.1	36.6	81.18	0.7677	17.33	99.21	0.03818	0.2100
30	52.8	40.5	80.64	0.8458	18.71	99.82	0.04100	0.2094
35	57.8	44.7	80.09	0.9300	20.10	100.4	0.04379	0.2088
40	63.2	49.3	79.53	1.021	21.49	101.0	0.04658	0.2083
45	69.0	54.2	78.96	1.118	22.90	101.6	0.04935	0.2078
50	75.1	59.5	78.39	1.223	24.32	102.2	0.05211	0.2073
55	81.7	65.1	77.81	1.335	25.74	102.8	0.05486	0.2068
60	88.6	71.2	77.23	1.456	27.17	103.3	0.05760	0.2063
65	96.0	77.6	76.63	1.585	28.62	103.9	0.06033	0.2059
70	103.8	84.5	76.02	1.723	30.07	104.4	0.06305	0.2055
75	112.1	91.8	75.41	1.871	31.53	105.0	0.06577	0.2051
80	120.9	99.7	74.78	2.029	33.01	105.5	0.06847	0.2047
85	130.2	108.0	74.15	2.198	34.50	106.0	0.07117	0.2043
90	140.0	116.8	73.50	2.379	35.99	106.5	0.07387	0.2039
95	150.3	126.1	72.84	2.572	37.51	107.0	0.07656	0.2035
100	161.1	136.0	72.17	2.778	39.03	107.5	0.07924	0.2031
105	172.5	146.5	71.48	2.998	40.57	107.9	0.08193	0.2027
110	184.6	157.5	70.78	3.233	42.12	108.4	0.08461	0.2024
115	197.2	169.2	70.06	3.484	43.69	108.8	0.08729	0.2020
120	210.4	181.5	69.33	3.753	45.28	109.2	0.08998	0.2016
125	224.2	194.4	68.57	4.040	46.88	109.6	0.09267	0.2012
130	238.7	208.1	67.80	4.348	48.50	110.0	0.09536	0.2008
135	253.9	222.4	67.00	4.677	50.14	110.3	0.09806	0.2004
140	269.7	237.5	66.18	5.031	51.80	110.6	0.1008	0.1999
145	286.3	253.3	65.34	5.412	53.49	110.9	0.1035	0.1995
150	303.6	270.0	64.46	5.821	55.20	111.1	0.1062	0.1990
155	321.7	287.4	63.55	6.263	56.94	111.4	0.1090	0.1984
160	340.5	305.7	62.60	6.741	58.71	111.5	0.1118	0.1979

Physical Properties of Refrigerants	R-416A
Environmental Classification	HCFC
Molecular Weight	111.9
Boiling Point (1 atm, F)	-10
Critical Pressure (psia)	582
Critical Temperature (F)	227
Critical Density (lb./ft ³)	32.3
Liquid Density (70 F, lb./ft ³)	77.68
Vapor Density (bp, lb./ft ³)	0.354
Heat of Vaporization (bp, BTU/lb.)	85.51
Specific Heat Liquid (70 F, BTU/lb. F)	0.3139
Specific Heat Vapor (1 atm, 70 F, BTU/lb. F)	0.1949
Ozone Depletion Potential (CFC 11 = 1.0)	0.012
Global Warming Potential (CO ₂ = 1.0)	1015
ASHRAE Standard 34 Safety Rating	A1
Temperature Glide (F) (see section II)	3

Available in the following sizes:

R-416A

25R416A 25 lb cylinder
125R416A 125 lb cylinder*

*Deposit Required

R-416A (R-134a/600/124)
(59 / 1.5 / 39.5 wt%)

This blend is based on R-134a. Intended for automotive retrofitting, in order to cut down on the high pressures generated after a retrofit, R-124 is added to the 134a. Hydrocarbon R-600 (butane) is added to improve mineral oil circulation. This blend matches R-12 at condenser temperatures, and pressures in the evaporator will need to be a few psi lower than R-12 to maintain proper temperature. Although the blend does not mix with mineral oils the addition of hydrocarbon thins the oil for satisfactory oil return. Systems will experience a loss of capacity, especially at lower evaporator temperatures.

Applications: automotive air conditioning, higher temperature refrigeration

Retrofitting: for R-12

page 89

Pressure-Temp Chart

Temp (F)	R-416A	
	Liquid (psig)	Vapor (psig)
-30	12.1	13.4
-25	9.6	11.0
-20	6.7	8.3
-15	3.5	5.3
-10	0.0	2.0
-5	1.9	0.8
0	4.0	2.8
5	6.3	5.0
10	8.9	7.4
15	11.6	10.0
20	14.6	12.8
25	17.8	15.9
30	21.4	19.3
35	25.2	22.9
40	29.3	26.8
45	33.7	31.1
50	38.4	35.6
55	43.5	40.5
60	49.0	45.7
65	54.8	51.3
70	61.1	57.3
75	67.7	63.7
80	74.8	70.6
85	82.3	77.8
90	90.3	85.5
95	98.8	93.7
100	108	102
105	117	112
110	127	121
115	138	132
120	149	143
125	161	154
130	173	166
135	186	179
140	200	192
145	214	206
150	229	221

THERMODYNAMIC PROPERTIES OF R-416A

<u>Temp</u> [F]	<u>Pressure</u> Liquid [psia]	<u>Pressure</u> Vapor [psia]	<u>Density</u> Liquid [lb/ft ³]	<u>Density</u> Vapor [lb/ft ³]	<u>Enthalpy</u> Liquid [Btu/lb]	<u>Enthalpy</u> Vapor [Btu/lb]	<u>Entropy</u> Liquid [Btu/R-lb]	<u>Entropy</u> Vapor [Btu/R-lb]
-40	6.6	6.1	88.98	0.1541	0.000	89.58	0.00000	0.2142
-35	7.6	7.0	88.49	0.1765	1.413	90.33	0.00334	0.2135
-30	8.7	8.1	88.00	0.2015	2.832	91.09	0.00666	0.2128
-25	10.0	9.3	87.50	0.2292	4.257	91.84	0.00995	0.2122
-20	11.4	10.6	87.00	0.2598	5.688	92.60	0.01322	0.2116
-15	13.0	12.1	86.50	0.2935	7.125	93.35	0.01646	0.2110
-10	14.7	13.8	86.00	0.3306	8.569	94.10	0.01968	0.2105
-5	16.7	15.6	85.49	0.3713	10.02	94.84	0.02288	0.2101
0	18.8	17.5	84.97	0.4159	11.48	95.59	0.02605	0.2097
5	21.1	19.7	84.45	0.4646	12.94	96.33	0.02921	0.2093
10	23.6	22.1	83.93	0.5177	14.41	97.07	0.03235	0.2089
15	26.3	24.7	83.40	0.5754	15.89	97.80	0.03546	0.2086
20	29.3	27.6	82.86	0.6381	17.37	98.53	0.03856	0.2083
25	32.6	30.7	82.32	0.7060	18.87	99.26	0.04164	0.2081
30	36.1	34.0	81.78	0.7796	20.37	100.0	0.04471	0.2078
35	39.9	37.6	81.22	0.8591	21.88	100.7	0.04776	0.2076
40	44.0	41.6	80.66	0.9448	23.39	101.4	0.05079	0.2074
45	48.4	45.8	80.10	1.037	24.92	102.1	0.05381	0.2073
50	53.2	50.3	79.52	1.137	26.46	102.8	0.05681	0.2071
55	58.3	55.2	78.94	1.244	28.00	103.5	0.05981	0.2070
60	63.7	60.4	78.35	1.359	29.55	104.2	0.06279	0.2069
65	69.6	66.0	77.76	1.483	31.12	104.9	0.06575	0.2068
70	75.8	72.0	77.15	1.615	32.69	105.5	0.06871	0.2067
75	82.4	78.4	76.53	1.757	34.28	106.2	0.07166	0.2066
80	89.5	85.2	75.90	1.909	35.87	106.8	0.07460	0.2065
85	97.0	92.5	75.27	2.072	37.48	107.5	0.07753	0.2064
90	105.0	100.2	74.62	2.247	39.10	108.1	0.08045	0.2064
95	113.5	108.4	73.95	2.433	40.73	108.7	0.08337	0.2063
100	122.4	117.0	73.28	2.633	42.38	109.3	0.08629	0.2063
105	131.9	126.2	72.59	2.847	44.04	109.9	0.08920	0.2062
110	141.9	136.0	71.88	3.076	45.71	110.5	0.09210	0.2061
115	152.5	146.2	71.16	3.322	47.40	111.0	0.09501	0.2061
120	163.6	157.1	70.42	3.584	49.11	111.6	0.09791	0.2060
125	175.4	168.5	69.67	3.866	50.83	112.1	0.1008	0.2059
130	187.7	180.6	68.89	4.168	52.57	112.6	0.1037	0.2058
135	200.7	193.3	68.09	4.492	54.33	113.1	0.1066	0.2057
140	214.4	206.6	67.26	4.841	56.12	113.5	0.1096	0.2056
145	228.7	220.7	66.41	5.216	57.92	113.9	0.1125	0.2054
150	243.8	235.4	65.52	5.622	59.75	114.3	0.1154	0.2052
155	259.5	250.9	64.61	6.060	61.61	114.7	0.1184	0.2050
160	276.0	267.2	63.65	6.534	63.50	115.0	0.1214	0.2048

Physical Properties of Refrigerants	R-417A
Environmental Classification	HFC
Molecular Weight	108.9
Boiling Point (1 atm, F)	-41.8
Critical Pressure (psia)	559
Critical Temperature (F)	194
Critical Density (lb./ft ³)	
Liquid Density (70 F, lb./ft ³)	72.85
Vapor Density (bp, lb./ft ³)	0.2447
Heat of Vaporization (bp, BTU/lb.)	89.5
Specific Heat Liquid (70 F, BTU/lb. F)	0.332
Specific Heat Vapor (1 atm, 70 F, BTU/lb. F)	0.2117
Ozone Depletion Potential (CFC 11 = 1.0)	0
Global Warming Potential (CO ₂ = 1.0)	2268
ASHRAE Standard 34 Safety Rating	A1
Temperature Glide (F) (see section II)	10

Available in the following sizes:

R-417A

25R417A 25 cylinder

R-417A (R-125/134a/600)
(46.6 / 50 / 3.4 wt%)

A blend of R-125, R-134a and hydrocarbon R-600 (butane) intended for use in air conditioning and refrigeration equipment (R-22 alternative). Both suction and discharge pressures will run lower than R-22, which may affect valve operation or orifice tube selection. Loss of capacity may be significant at lower evaporator temperatures. Addition of the hydrocarbon will help with mineral oil circulation, however the HFC refrigerant components will still not mix with the oil, causing possible problems in larger systems (POE may be required).

Applications: air conditioning, higher temperature refrigeration

Retrofitting: for R-22 page 90

Pressure-Temp Chart

Temp (F)	R-417A	
	Liquid (psig)	Vapor (psig)
-40	0.5	4.2
-35	2.4	0.8
-30	4.5	1.5
-25	6.9	3.6
-20	9.4	5.9
-15	12.2	8.4
-10	15.2	11.2
-5	18.5	14.3
0	22.0	17.6
5	25.9	21.2
10	30.0	25.1
15	34.5	29.3
20	39.3	33.9
25	44.5	38.9
30	56.8	44.2
35	56.0	49.9
40	62.4	56.1
45	69.2	62.7
50	76.4	69.8
55	87.2	77.3
60	95.7	85.4
65	105	93.9
70	114	103
75	124	113
80	134	123
85	146	134
90	157	145
95	170	158
100	183	170
105	197	184
110	211	198
115	225	212
120	241	227
125	258	244
130	275	261
135	293	279
140	312	297

THERMODYNAMIC PROPERTIES OF R-417A

Temp [F]	Pressure	Pressure	Density	Density	Enthalpy	Enthalpy	Entropy	Entropy
	Liquid [psia]	Vapor [psia]	Liquid [lb/ft ³]	Vapor [lb/ft ³]	Liquid [Btu/lb]	Vapor [Btu/lb]	Liquid [Btu/R-lb]	Vapor [Btu/R-lb]
-60	7.7	5.7	88.79	0.1454	-5.82	82.82	-0.01420	0.2102
-55	8.9	6.7	88.28	0.1682	-4.38	83.62	-0.01060	0.2093
-50	10.2	7.8	87.76	0.1938	-2.93	84.32	-0.00700	0.2084
-45	11.7	9.0	87.24	0.2224	-1.47	85.12	-0.00350	0.2076
-40	13.4	10.4	86.71	0.2542	0.00	85.92	0.00000	0.2068
-35	15.2	11.9	86.18	0.2896	1.47	86.62	0.00350	0.2061
-30	17.3	13.6	85.65	0.3287	2.95	87.42	0.00690	0.2055
-25	19.5	15.5	85.11	0.3719	4.43	88.12	0.01040	0.2049
-20	22.0	17.7	84.56	0.4194	5.92	88.92	0.01380	0.2043
-15	24.7	20.0	84.01	0.4716	7.43	89.62	0.01710	0.2038
-10	27.7	22.6	83.46	0.5288	8.93	90.42	0.02050	0.2034
-5	30.9	25.4	82.90	0.5913	10.45	91.12	0.02380	0.2029
0	34.5	28.5	82.33	0.6595	11.98	91.82	0.02720	0.2025
5	38.3	31.8	81.76	0.7337	13.51	92.62	0.03050	0.2022
10	42.4	35.5	81.18	0.8144	15.06	93.32	0.03370	0.2018
15	46.9	39.5	80.59	0.9020	16.61	94.02	0.03700	0.2015
20	51.7	43.8	79.99	0.9969	18.17	94.72	0.04030	0.2012
25	56.9	48.5	79.39	1.100	19.74	95.42	0.04350	0.2010
30	62.5	53.6	78.77	1.211	21.33	96.12	0.04670	0.2008
35	68.5	59.0	78.15	1.331	22.92	96.82	0.04990	0.2005
40	74.9	64.9	77.52	1.460	24.52	97.52	0.05310	0.2003
45	81.7	71.1	76.88	1.599	26.14	98.12	0.05630	0.2002
50	89.0	77.9	76.22	1.749	27.77	98.82	0.05950	0.2000
55	96.8	85.1	75.55	1.911	29.41	99.52	0.06270	0.1998
60	105.1	92.8	74.88	2.084	31.07	100.1	0.06580	0.1997
65	113.9	101.0	74.18	2.271	32.73	100.7	0.06900	0.1995
70	123.2	109.8	73.48	2.471	34.42	101.3	0.07210	0.1994
75	133.1	119.1	72.75	2.687	36.12	101.9	0.07530	0.1993
80	143.6	129.0	72.01	2.919	37.82	102.5	0.07840	0.1991
85	154.7	139.5	71.26	3.168	39.52	103.1	0.08150	0.1990
90	166.4	150.7	70.48	3.436	41.32	103.6	0.08470	0.1989
95	178.8	162.5	69.68	3.724	43.12	104.1	0.08780	0.1987
100	191.8	175.0	68.86	4.035	44.82	104.7	0.09100	0.1985
105	205.5	188.2	68.01	4.370	46.72	105.1	0.09410	0.1983
110	220.0	202.1	67.13	4.732	48.52	105.6	0.09730	0.1981
115	235.1	216.8	66.23	5.123	50.42	106.0	0.1005	0.1979
120	251.1	232.3	65.29	5.546	52.22	106.4	0.1037	0.1977
125	267.8	248.7	64.31	6.007	54.22	106.8	0.1069	0.1974
130	285.4	265.9	63.28	6.508	56.12	107.1	0.1101	0.1970
135	303.8	284.0	62.21	7.057	58.12	107.3	0.1134	0.1966
140	323.1	303.1	61.08	7.659	60.12	107.5	0.1167	0.1962

Physical Properties of Refrigerants	R-500	R-502
Environmental Classification	CFC	CFC
Molecular Weight	99.3	111.6
Boiling Point (1 atm, F)	-28.5	-49.5
Critical Pressure (psia)	605.2	582.8
Critical Temperature (F)	215.8	177.3
Critical Density (lb./ft ³)	30.7	35.5
Liquid Density (70 F, lb./ft ³)	73	77
Vapor Density (bp, lb./ft ³)	0.329	0.388
Heat of Vaporization (bp, BTU/lb.)	86.4	74.2
Specific Heat Liquid (70 F, BTU/lb. F)	0.2782	0.2958
Specific Heat Vapor (1 atm, 70 F, BTU/lb. F)	0.1725	0.1641
Ozone Depletion Potential (CFC 11 = 1.0)	0.66	0.23
Global Warming Potential (CO ₂ = 1.0)	7943	4581
ASHRAE Standard 34 Safety Rating	A1	A1

Available in the following sizes:

R-500

30R500	30 lb cylinder
50R500	50 lb cylinder
125R500	125 lb cylinder*
875R500	½ ton cylinder*
1750R500	1 ton cylinder*

R-502

30R502	30 lb cylinder
50R502	50 lb cylinder
125R502	125 lb cylinder*
875R502	½ ton cylinder*
1750R502	1 ton cylinder*

*Deposit Required

National Refrigerants still has significant quantities of CFC refrigerants for sale. As an EPA Certified Reclaimer we are able to consistently return used R-500, R-502, and other CFCs to ARI-700 specifications for purity.

AZEOTROPE: A mixture of two or more refrigerants in which the liquid and vapor have the same composition at equilibrium. In addition, the resulting pressure of the mixture is either higher or lower than the pressure of any of its components. Azeotropes behave like pure component refrigerants because there is no change in boiling temperature or shift in composition during phase change, equipment operation or leakage.

R-500 (R-12/152a, 73.8/26.2 wt%)

Applications: air conditioning, dehumidifiers, centrifugal chillers

Retrofitting To:	R-134a	page (to be added)
	R-401A, R-401B	page 91
	R-409A	page 91

R-502 (R-22/115, 48.8/51.2 wt%)

Applications: low temperature refrigeration, ice machines

Retrofitting To:	R-402A, R-402B	page 92
	R-404A, R-507	page (to be added)
	R-408A	page 92

Pressure-Temp Chart

Temp (F)	R500 (psig)	R502 (psig)
-40	7.6"	4.1
-35	4.6"	6.5
-30	1.2"	9.2
-25	1.2	12.1
-20	3.2	15.3
-15	5.4	18.8
-10	7.8	22.6
-5	10.4	26.7
0	13.3	31.1
5	16.4	35.9
10	19.7	41.0
15	23.4	46.5
20	27.3	52.4
25	31.5	58.8
30	36.0	65.6
35	40.9	72.8
40	46.1	80.5
45	51.6	88.7
50	57.6	97.4
55	63.9	107
60	70.6	116
65	77.8	127
70	85.4	138
75	93.5	149
80	102	161
85	111	174
90	121	187
95	131	201
100	141	216
105	152	232
110	164	248
115	177	265
120	189	283
125	203	301
130	217	321
135	232	341
140	248	363

THERMODYNAMIC PROPERTIES OF R-500

Temp [F]	Pressure	Pressure	Density	Density	Enthalpy	Enthalpy	Entropy	Entropy
	Liquid [psia]	Vapor [psia]	Liquid [lb/ft ³]	Vapor [lb/ft ³]	Liquid [Btu/lb]	Vapor [Btu/lb]	Liquid [Btu/R-lb]	Vapor [Btu/R-lb]
-60	6.3	6.3	85.26	0.1498	-5.016	85.98	-0.01222	0.2155
-55	7.3	7.3	84.81	0.1713	-3.770	86.63	-0.00913	0.2143
-50	8.4	8.4	84.35	0.1951	-2.519	87.27	-0.00606	0.2131
-45	9.6	9.6	83.89	0.2215	-1.262	87.92	-0.00302	0.2120
-40	11.0	11.0	83.43	0.2506	0.000	88.56	0.00000	0.2110
-35	12.5	12.5	82.97	0.2826	1.268	89.20	0.00299	0.2100
-30	14.2	14.2	82.50	0.3177	2.541	89.83	0.00597	0.2091
-25	16.0	16.0	82.03	0.3561	3.820	90.47	0.00892	0.2083
-20	18.0	18.0	81.55	0.3980	5.106	91.10	0.01185	0.2074
-15	20.2	20.2	81.07	0.4436	6.397	91.73	0.01476	0.2066
-10	22.6	22.6	80.59	0.4932	7.695	92.35	0.01765	0.2059
-5	25.3	25.3	80.10	0.5470	9.000	92.97	0.02052	0.2052
0	28.1	28.1	79.61	0.6053	10.31	93.58	0.02337	0.2045
5	31.3	31.2	79.11	0.6682	11.63	94.19	0.02621	0.2039
10	34.6	34.6	78.61	0.7362	12.96	94.80	0.02903	0.2033
15	38.3	38.2	78.10	0.8095	14.29	95.40	0.03184	0.2027
20	42.2	42.1	77.59	0.8883	15.63	95.99	0.03463	0.2022
25	46.4	46.4	77.07	0.9730	16.98	96.58	0.03741	0.2016
30	50.9	50.9	76.55	1.064	18.34	97.16	0.04017	0.2011
35	55.8	55.7	76.01	1.161	19.70	97.73	0.04292	0.2007
40	61.0	60.9	75.48	1.266	21.08	98.29	0.04566	0.2002
45	66.6	66.5	74.93	1.378	22.46	98.85	0.04838	0.1998
50	72.5	72.4	74.38	1.497	23.85	99.40	0.05110	0.1993
55	78.9	78.7	73.82	1.625	25.25	99.94	0.05381	0.1989
60	85.6	85.4	73.25	1.761	26.66	100.5	0.05650	0.1985
65	92.8	92.5	72.67	1.907	28.09	101.0	0.05919	0.1982
70	100.4	100.1	72.08	2.062	29.52	101.5	0.06187	0.1978
75	108.4	108.1	71.48	2.228	30.96	102.0	0.06455	0.1974
80	116.9	116.6	70.87	2.405	32.42	102.5	0.06722	0.1970
85	125.9	125.5	70.25	2.593	33.89	102.9	0.06988	0.1967
90	135.4	135.0	69.62	2.794	35.37	103.4	0.07254	0.1963
95	145.5	145.0	68.98	3.008	36.86	103.8	0.07520	0.1960
100	156.1	155.5	68.32	3.236	38.37	104.3	0.07785	0.1956
105	167.2	166.6	67.64	3.479	39.89	104.7	0.08051	0.1952
110	178.9	178.2	66.95	3.739	41.43	105.0	0.08316	0.1949
115	191.2	190.4	66.25	4.016	42.99	105.4	0.08582	0.1945
120	204.1	203.3	65.52	4.313	44.56	105.8	0.08849	0.1941
125	217.7	216.8	64.77	4.630	46.15	106.1	0.09115	0.1937
130	231.9	230.9	64.00	4.970	47.77	106.4	0.09383	0.1933
135	246.8	245.7	63.21	5.335	49.40	106.6	0.09652	0.1928
140	262.4	261.2	62.39	5.726	51.06	106.9	0.09922	0.1923
145	278.7	277.4	61.54	6.148	52.74	107.1	0.1019	0.1918
150	295.7	294.4	60.66	6.604	54.45	107.2	0.1047	0.1913
155	313.6	312.1	59.73	7.097	56.20	107.3	0.1074	0.1907

THERMODYNAMIC PROPERTIES OF R-502

<u>Temp</u> [F]	<u>Pressure</u> Liquid [psia]	<u>Pressure</u> Vapor [psia]	<u>Density</u> Liquid [lb/ft ³]	<u>Density</u> Vapor [lb/ft ³]	<u>Enthalpy</u> Liquid [Btu/lb]	<u>Enthalpy</u> Vapor [Btu/lb]	<u>Entropy</u> Liquid [Btu/R-lb]	<u>Entropy</u> Vapor [Btu/R-lb]
-60	11.1	10.9	93.91	0.2941	-4.736	70.99	-0.01153	0.1781
-55	12.7	12.5	93.35	0.3342	-3.561	71.59	-0.00861	0.1772
-50	14.5	14.3	92.78	0.3786	-2.380	72.18	-0.00572	0.1764
-45	16.5	16.3	92.20	0.4273	-1.193	72.77	-0.00285	0.1756
-40	18.7	18.5	91.62	0.4808	0.000	73.36	0.00000	0.1749
-35	21.1	20.9	91.04	0.5394	1.200	73.95	0.00283	0.1742
-30	23.7	23.5	90.45	0.6034	2.406	74.53	0.00564	0.1736
-25	26.6	26.4	89.85	0.6731	3.619	75.11	0.00843	0.1730
-20	29.8	29.6	89.25	0.7490	4.839	75.68	0.01121	0.1724
-15	33.2	33.0	88.64	0.8313	6.066	76.25	0.01397	0.1719
-10	37.0	36.8	88.03	0.9205	7.301	76.81	0.01671	0.1713
-5	41.0	40.8	87.40	1.017	8.544	77.37	0.01944	0.1709
0	45.4	45.2	86.78	1.121	9.795	77.92	0.02216	0.1704
5	50.1	50.0	86.14	1.234	11.05	78.47	0.02486	0.1700
10	55.2	55.1	85.49	1.355	12.32	79.00	0.02755	0.1696
15	60.7	60.6	84.84	1.486	13.60	79.53	0.03023	0.1692
20	66.6	66.5	84.17	1.626	14.89	80.06	0.03290	0.1688
25	72.9	72.8	83.50	1.777	16.18	80.57	0.03556	0.1684
30	79.6	79.5	82.82	1.939	17.49	81.07	0.03821	0.1681
35	86.8	86.7	82.12	2.113	18.80	81.57	0.04085	0.1677
40	94.5	94.4	81.42	2.299	20.13	82.05	0.04348	0.1674
45	102.7	102.6	80.70	2.499	21.47	82.52	0.04611	0.1671
50	111.4	111.3	79.97	2.712	22.82	82.98	0.04874	0.1668
55	120.6	120.5	79.22	2.942	24.18	83.43	0.05135	0.1665
60	130.4	130.3	78.46	3.187	25.56	83.86	0.05397	0.1662
65	140.7	140.7	77.68	3.450	26.95	84.28	0.05658	0.1659
70	151.7	151.6	76.88	3.731	28.35	84.68	0.05920	0.1656
75	163.3	163.2	76.07	4.033	29.77	85.07	0.06181	0.1652
80	175.5	175.4	75.23	4.357	31.20	85.43	0.06442	0.1649
85	188.4	188.3	74.37	4.705	32.66	85.78	0.06704	0.1646
90	201.9	201.9	73.49	5.079	34.13	86.10	0.06967	0.1642
95	216.2	216.2	72.58	5.481	35.62	86.40	0.07230	0.1639
100	231.3	231.2	71.64	5.914	37.13	86.67	0.07495	0.1635
105	247.1	247.0	70.66	6.382	38.67	86.91	0.07761	0.1630
110	263.6	263.6	69.65	6.889	40.23	87.11	0.08029	0.1626
115	281.0	281.0	68.59	7.438	41.82	87.28	0.08298	0.1621
120	299.3	299.3	67.48	8.037	43.44	87.41	0.08571	0.1616
125	318.4	318.4	66.32	8.692	45.10	87.49	0.08847	0.1610
130	338.5	338.5	65.08	9.412	46.80	87.51	0.09127	0.1603
135	359.5	359.5	63.77	10.21	48.55	87.47	0.09412	0.1596
140	381.4	381.4	62.36	11.10	50.36	87.35	0.09704	0.1587

Physical Properties of Refrigerants	R-503
Environmental Classification	CFC
Molecular Weight	82.3
Boiling Point (1 atm, F)	-125.5
Critical Pressure (psia)	618.6
Critical Temperature (F)	65.2
Critical Density (lb./ft ³)	34.4
Liquid Density (70 F, lb./ft ³)	66.3
Vapor Density (bp, lb./ft ³)	0.373
Heat of Vaporization (bp, BTU/lb.)	77.1
Specific Heat Liquid (70 F, BTU/lb. F)	0.3774
Specific Heat Vapor (1 atm, 70 F, BTU/lb. F)	0.1537
Ozone Depletion Potential (CFC 11 = 1.0)	0.06
Global Warming Potential (CO ₂ = 1.0)	13408
ASHRAE Standard 34 Safety Rating	A1

Available in the following sizes:

R-503

- 5R503 5 lb cylinder
- 9R503 9 lb cylinder*
- 20R503 23 lb cylinder*
- 80R503 80 lb cylinder*

*Deposit Required

Very low temperature refrigeration systems typically operate in two or more stages (cascade type systems). It would be nearly impossible to achieve low temperatures in a single stage with an inexpensive compressor. The traditional cascade system has a low temperature stage that uses the lower boiling point gas, such as R-13 or R-503, and a high stage that typically uses R-12, R-22 or R-502.

The high stage evaporator provides the correct condensation temperature for the low stage so that compressors in both stages can run at “normal” pressures.

R-503 (R-23/13)
(40.1/59.9 wt%)

Applications: Very low temperature refrigeration (low stage of a cascade system)

Retrofitting: R-508B page (to be added)

Pressure-Temp Chart

Temp (F)	R503 (psig)
-125	0.5
-120	3.1
-115	6.0
-110	9.3
-105	12.9
-100	16.9
-95	21.4
-90	26.3
-85	31.8
-80	37.7
-75	44.2
-70	51.3
-65	59.0
-60	67.3
-55	76.4
-50	86.1
-45	96.6
-40	108
-35	120
-30	133
-25	147
-20	161
-15	177
-10	194
-5	212
0	230
5	250
10	272
15	294
20	318

THERMODYNAMIC PROPERTIES OF R-503

Temp [F]	Pressure Liquid [psia]	Pressure Vapor [psia]	Density Liquid [lb/ft ³]	Density Vapor [lb/ft ³]	Enthalpy Liquid [Btu/lb]	Enthalpy Vapor [Btu/lb]	Entropy Liquid [Btu/R-lb]	Entropy Vapor [Btu/R-lb]
-140	9.1	9.1	94.67	0.2374	-25.81	53.32	-0.06936	0.1782
-135	10.8	10.8	94.04	0.2788	-24.60	53.82	-0.06562	0.1759
-130	12.7	12.7	93.40	0.3257	-23.39	54.30	-0.06192	0.1737
-125	14.9	14.9	92.75	0.3785	-22.16	54.79	-0.05826	0.1717
-120	17.4	17.4	92.09	0.4377	-20.94	55.26	-0.05464	0.1697
-115	20.3	20.2	91.43	0.5039	-19.70	55.73	-0.05105	0.1678
-110	23.5	23.4	90.75	0.5776	-18.46	56.19	-0.04748	0.1660
-105	27.0	26.9	90.06	0.6595	-17.21	56.64	-0.04395	0.1643
-100	31.0	30.9	89.36	0.7500	-15.95	57.08	-0.04045	0.1627
-95	35.4	35.2	88.65	0.8500	-14.68	57.51	-0.03698	0.1611
-90	40.2	40.0	87.93	0.9601	-13.40	57.93	-0.03352	0.1595
-85	45.6	45.3	87.19	1.081	-12.12	58.34	-0.03010	0.1580
-80	51.4	51.1	86.44	1.214	-10.82	58.74	-0.02669	0.1566
-75	57.9	57.5	85.67	1.359	-9.512	59.12	-0.02330	0.1552
-70	64.9	64.4	84.89	1.517	-8.192	59.49	-0.01993	0.1539
-65	72.5	72.0	84.09	1.690	-6.861	59.85	-0.01658	0.1525
-60	80.8	80.1	83.28	1.878	-5.517	60.19	-0.01324	0.1513
-55	89.7	89.0	82.45	2.083	-4.159	60.51	-0.00992	0.1500
-50	99.4	98.6	81.60	2.306	-2.788	60.82	-0.00660	0.1488
-45	109.9	108.9	80.72	2.549	-1.402	61.11	-0.00330	0.1476
-40	121.1	120.0	79.83	2.812	0.000	61.37	0.00000	0.1464
-35	133.2	131.9	78.91	3.097	1.419	61.62	0.00329	0.1452
-30	146.1	144.7	77.96	3.408	2.855	61.84	0.00659	0.1440
-25	160.0	158.3	76.99	3.745	4.312	62.04	0.00988	0.1428
-20	174.8	172.9	75.99	4.112	5.789	62.21	0.01318	0.1416
-15	190.5	188.5	74.95	4.511	7.289	62.35	0.01648	0.1404
-10	207.3	205.1	73.87	4.946	8.813	62.45	0.01980	0.1392
-5	225.2	222.7	72.76	5.421	10.37	62.52	0.02313	0.1379
0	244.1	241.5	71.59	5.941	11.95	62.54	0.02648	0.1367
5	264.2	261.4	70.37	6.512	13.56	62.52	0.02987	0.1353
10	285.6	282.5	69.09	7.142	15.22	62.44	0.03329	0.1339
15	308.1	304.8	67.74	7.839	16.92	62.30	0.03676	0.1325
20	332.0	328.5	66.31	8.616	18.67	62.09	0.04029	0.1309

Physical Properties of Refrigerants	R-503
Environmental Classification	HFC
Molecular Weight	98.9
Boiling Point (1 atm, F)	-52.8
Critical Pressure (psia)	539
Critical Temperature (F)	159
Critical Density (lb./ft ³)	30.7
Liquid Density (70 F, lb./ft ³)	66.65
Vapor Density (bp, lb./ft ³)	0.349
Heat of Vaporization (bp, BTU/lb.)	84.35
Specific Heat Liquid (70 F, BTU/lb. F)	0.3593
Specific Heat Vapor (1 atm, 70 F, BTU/lb. F)	0.2064
Ozone Depletion Potential (CFC 11 = 1.0)	0
Global Warming Potential (CO ₂ = 1.0)	3925
ASHRAE Standard 34 Safety Rating	A1

Available in the following sizes:

R-507

25R507 25 lb cylinder
100R507 100 lb cylinder*
1400R507 1 ton cylinder*

*Deposit Required

R-507 (R-125/143a)
(50 / 50 wt%)

An azeotropic blend of R-125 and R-143a intended for low temperature and medium temperature refrigeration. Similar to R-404A in operation, most new equipment has been built to use either blend interchangeably. The pressure and capacity of R-507 are slightly higher than R-404A, and both are higher than R-502. R-507 requires POE lubricant. If retrofitting R-502 equipment, oil flushing will be required.

Applications: low temperature and medium temperature refrigeration

Retrofitting: for R-502 page (to be added)
for R-22 page (to be added)

Pressure-Temp Chart

Temp (F)	R507 (psig)
-40	5.5
-35	8.2
-30	11.1
-25	14.3
-20	17.8
-15	21.7
-10	25.8
-5	30.3
0	35.2
5	40.5
10	46.1
15	52.2
20	58.8
25	65.8
30	73.3
35	81.3
40	89.8
45	98.9
50	109
55	119
60	130
65	141
70	154
75	167
80	180
85	195
90	210
95	226
100	244
105	252
110	281
115	301
120	322
125	344
130	368
135	393
140	419
145	446
150	475

THERMODYNAMIC PROPERTIES OF R-507

<u>Temp</u> [F]	<u>Pressure</u> Liquid [psia]	<u>Pressure</u> Vapor [psia]	<u>Density</u> Liquid [lb/ft ³]	<u>Density</u> Vapor [lb/ft ³]	<u>Enthalpy</u> Liquid [Btu/lb]	<u>Enthalpy</u> Vapor [Btu/lb]	<u>Entropy</u> Liquid [Btu/R-lb]	<u>Entropy</u> Vapor [Btu/R-lb]
-60	12.1	12.1	83.10	0.2899	-5.871	79.54	-0.01429	0.1994
-55	13.9	13.9	82.57	0.3298	-4.416	80.26	-0.01068	0.1986
-50	15.8	15.8	82.03	0.3738	-2.952	80.98	-0.00709	0.1978
-45	18.0	18.0	81.49	0.4223	-1.480	81.69	-0.00354	0.1970
-40	20.4	20.4	80.94	0.4756	0.000	82.40	0.00000	0.1964
-35	23.1	23.1	80.39	0.5340	1.489	83.11	0.00351	0.1957
-30	26.0	26.0	79.83	0.5980	2.987	83.81	0.00700	0.1951
-25	29.2	29.2	79.27	0.6678	4.494	84.51	0.01047	0.1946
-20	32.7	32.7	78.70	0.7439	6.010	85.20	0.01392	0.1940
-15	36.5	36.5	78.12	0.8267	7.537	85.88	0.01735	0.1935
-10	40.7	40.7	77.53	0.9166	9.073	86.56	0.02077	0.1931
-5	45.2	45.2	76.94	1.014	10.62	87.23	0.02417	0.1927
0	50.1	50.0	76.34	1.120	12.18	87.89	0.02755	0.1923
5	55.3	55.3	75.73	1.234	13.75	88.55	0.03091	0.1919
10	61.0	60.9	75.11	1.357	15.33	89.19	0.03427	0.1915
15	67.1	67.0	74.48	1.491	16.92	89.83	0.03761	0.1912
20	73.6	73.6	73.84	1.634	18.52	90.45	0.04094	0.1909
25	80.6	80.6	73.18	1.789	20.14	91.07	0.04426	0.1906
30	88.1	88.1	72.52	1.956	21.77	91.67	0.04757	0.1903
35	96.1	96.1	71.84	2.136	23.42	92.26	0.05087	0.1900
40	104.7	104.6	71.15	2.329	25.08	92.84	0.05417	0.1898
45	113.8	113.7	70.45	2.537	26.76	93.40	0.05746	0.1895
50	123.5	123.4	69.73	2.761	28.45	93.94	0.06075	0.1892
55	133.8	133.7	68.99	3.002	30.17	94.47	0.06404	0.1890
60	144.7	144.6	68.23	3.262	31.90	94.97	0.06733	0.1887
65	156.3	156.1	67.45	3.541	33.65	95.46	0.07062	0.1884
70	168.5	168.3	66.65	3.843	35.42	95.92	0.07392	0.1882
75	181.5	181.3	65.82	4.169	37.21	96.36	0.07722	0.1879
80	195.1	194.9	64.97	4.521	39.03	96.77	0.08053	0.1875
85	209.6	209.4	64.08	4.902	40.87	97.15	0.08386	0.1872
90	224.8	224.6	63.17	5.315	42.75	97.50	0.08720	0.1868
95	240.8	240.6	62.21	5.764	44.65	97.80	0.09056	0.1864
100	257.7	257.5	61.21	6.255	46.59	98.07	0.09395	0.1859
105	275.5	275.2	60.17	6.792	48.57	98.28	0.09737	0.1854
110	294.2	293.9	59.07	7.382	50.59	98.43	0.1008	0.1848
115	313.8	313.5	57.91	8.035	52.66	98.52	0.1043	0.1842
120	334.4	334.1	56.67	8.762	54.79	98.53	0.1079	0.1834
125	356.1	355.8	55.34	9.580	56.98	98.44	0.1116	0.1825
130	378.8	378.6	53.89	10.51	59.26	98.24	0.1153	0.1814
135	402.7	402.5	52.29	11.59	61.64	97.87	0.1192	0.1801
140	427.9	427.6	50.50	12.86	64.17	97.30	0.1233	0.1785

Physical Properties of Refrigerants	R-508B
Environmental Classification	HFC
Molecular Weight	95.4
Boiling Point (1 atm, F)	-125.3
Critical Pressure (psia)	556.1
Critical Temperature (F)	53.7
Critical Density (lb./ft ³)	35.6
Liquid Density (70 F, lb./ft ³)	65.63
Vapor Density (bp, lb./ft ³)	0.409
Heat of Vaporization (bp, BTU/lb.)	71.4
Specific Heat Liquid (70 F, BTU/lb. F)	0.4263
Specific Heat Vapor (1 atm, 70 F, BTU/lb. F)	0.1701
Ozone Depletion Potential (CFC 11 = 1.0)	0
Global Warming Potential (CO ₂ = 1.0)	11030
ASHRAE Standard 34 Safety Rating	A1

Available in the following sizes:

R-508B

5R508B 5 lb cylinder
 10R508B 10 lb cylinder*
 20R508B 20 lb cylinder*
 70R508B 70 lb cylinder*

*Deposit Required

A blend of R-23 and R-116 intended for very low temperature refrigeration systems. R-508B has properties very similar to R-503 and can be used to replace R-13 or R-503 in an existing system. New equipment is mostly being manufactured with R-508B in the low stage. POE lubricants should be used and it may still be necessary to use hydrocarbon additives to help with oil circulation. Check with OEM for specific oil and charging recommendations.

R-508B (R-23/116)
 (46 / 54 wt%)

Applications: Very low temperature refrigeration (low stage of a cascade system)

Retrofitting: for R-503 page (to be added)

Pressure-Temp Chart

Temp (F)	R508B (psig)
-125	0.5
-120	3.1
-115	6.0
-110	9.3
-105	12.9
-100	16.9
-95	21.4
-90	26.4
-85	31.8
-80	37.8
-75	44.4
-70	51.5
-65	59.3
-60	67.8
-55	76.9
-50	86.8
-45	97.5
-40	109
-35	121
-30	135
-25	149
-20	164
-15	180
-10	197
-5	216
0	235
5	256
10	278
15	301
20	326

THERMODYNAMIC PROPERTIES OF R-508B

<u>Temp</u> [F]	<u>Pressure</u>		<u>Density</u>		<u>Enthalpy</u>		<u>Entropy</u>	
	Liquid [psia]	Vapor [psia]	Liquid [lb/ft ³]	Vapor [lb/ft ³]	Liquid [Btu/lb]	Vapor [Btu/lb]	Liquid [Btu/R-lb]	Vapor [Btu/R-lb]
-160	4.1	3.9	100.7	0.1181	-32.27	44.15	-0.08953	0.1664
-155	5.1	4.8	99.96	0.1438	-30.98	44.72	-0.08527	0.1640
-150	6.2	5.9	99.24	0.1737	-29.70	45.29	-0.08109	0.1618
-145	7.5	7.2	98.52	0.2083	-28.42	45.85	-0.07699	0.1596
-140	8.9	8.6	97.80	0.2482	-27.14	46.40	-0.07297	0.1576
-135	10.6	10.3	97.08	0.2937	-25.86	46.95	-0.06900	0.1557
-130	12.6	12.3	96.37	0.3455	-24.57	47.49	-0.06509	0.1539
-125	14.8	14.5	95.65	0.4041	-23.29	48.03	-0.06124	0.1522
-120	17.4	17.1	94.92	0.4701	-22.00	48.56	-0.05743	0.1505
-115	20.2	19.9	94.19	0.5441	-20.70	49.08	-0.05366	0.1490
-110	23.4	23.1	93.45	0.6269	-19.40	49.59	-0.04993	0.1476
-105	27.0	26.7	92.70	0.7191	-18.09	50.10	-0.04623	0.1462
-100	31.0	30.8	91.94	0.8214	-16.77	50.59	-0.04256	0.1449
-95	35.5	35.2	91.18	0.9347	-15.45	51.08	-0.03892	0.1436
-90	40.4	40.1	90.39	1.060	-14.11	51.56	-0.03531	0.1424
-85	45.8	45.6	89.60	1.198	-12.76	52.02	-0.03172	0.1412
-80	51.7	51.6	88.79	1.349	-11.40	52.48	-0.02815	0.1401
-75	58.3	58.1	87.96	1.515	-10.03	52.92	-0.02460	0.1391
-70	65.4	65.3	87.12	1.697	-8.648	53.35	-0.02106	0.1381
-65	73.2	73.0	86.25	1.896	-7.249	53.76	-0.01753	0.1371
-60	81.6	81.5	85.36	2.114	-5.834	54.17	-0.01402	0.1361
-55	90.7	90.7	84.45	2.351	-4.403	54.55	-0.01051	0.1352
-50	100.6	100.6	83.51	2.611	-2.955	54.92	-0.00701	0.1343
-45	111.3	111.3	82.55	2.893	-1.487	55.27	-0.00350	0.1334
-40	122.8	122.8	81.55	3.202	0.000	55.60	0.00000	0.1325
-35	135.2	135.1	80.52	3.539	1.509	55.90	0.00351	0.1316
-30	148.4	148.4	79.45	3.906	3.041	56.18	0.00702	0.1307
-25	162.6	162.6	78.34	4.308	4.598	56.44	0.01055	0.1298
-20	177.8	177.8	77.18	4.748	6.182	56.66	0.01409	0.1289
-15	194.0	194.0	75.98	5.231	7.796	56.85	0.01765	0.1280
-10	211.3	211.3	74.72	5.763	9.441	56.99	0.02123	0.1270
-5	229.7	229.6	73.40	6.350	11.12	57.10	0.02484	0.1260
0	249.3	249.2	72.02	7.000	12.84	57.15	0.02849	0.1249
5	270.1	270.0	70.56	7.725	14.59	57.13	0.03218	0.1237
10	292.2	292.1	69.02	8.540	16.40	57.05	0.03592	0.1225
15	315.7	315.6	67.39	9.461	18.26	56.88	0.03972	0.1211
20	340.6	340.5	65.63	10.52	20.18	56.60	0.04361	0.1195

Refrigerant Color Codes (ARI Guideline K)

Refrigerant	Chemical Name	Color	PMS #
R11	Trichlorofluoromethane	Orange	021
R12	Dichlorodifluoromethane	White	N/A
R13	Chlorotrifluoromethane	Light Blue	2975
R113	Trichlorotrifluoroethane	Dark Purple	266
R114	Dichlorotetrafluoroethane	Navy Blue	302
R12/114	Dichlorodifluoromethane, Dichlorotetrafluoroethane	Light Gray	413
R13B1	Bromotrifluoromethane	Pinkish-Red	177
R22	Chlorodifluoromethane	Light Green	352
R23	Trifluoromethane	Light Blue Gray	428
R123	Dichlorotrifluoroethane	Light Blue Gray	428
R124	Chlorotetrafluoroethane	DOT Green	335
134a	Tetrafluoroethane	Light Blue	2975
R401A	Chlorodifluoromethane, Difluoroethane, Chlorotetrafluoroethane	Pinkish-Red	177
R401B	Chlorodifluoromethane, Difluoroethane, Chlorotetrafluoroethane	Yellow-Brown	124
R402A	Chlorodifluoromethane, Pentafluoroethane, Propane	Light Brown	461
R402B	Chlorodifluoromethane, Pentafluoroethane, Propane	Green-Brown	385
R403B	Chlorodifluoromethane, Octafluoropropane, Propane	Light Gray	413
R404A	Pentafluoroethane, Trifluoroethane, Tetrafluoroethane	Orange	021
R407C	Difluoromethane, Pentafluoroethane, Tetrafluoroethane	Brown	471
R408A	Chlorodifluoromethane, Trifluoroethane, Pentafluoroethane	Medium Purple	248
R409A	Chlorodifluoromethane, Chlorotetrafluoroethane, Chlorodifluoroethane	Medium Brown	465
R410A	Difluoromethane, Pentafluoroethane	Rose	507
R414B	Chlorodifluoromethane, Chlorotetrafluoroethane, Chlorodifluoroethane, Isobutane	Medium Blue	2995
R416A	Tetrafluoroethane, Chlorotetrafluoroethane, Butane	Yellow-Green	381
R417A	Pentafluoroethane, Tetrafluoroethane, Isobutane	Green	3275
R500	Dichlorodifluoromethane, Difluoroethane	Yellow	109
R502	Chlorodifluoromethane, Chloropentafluoroethane	Light Purple	251
R503	Chlorotrifluoromethane, Trifluoromethane	Blue-Green	3268
R507	Pentafluoroethane, Trifluoroethane	Aqua Blue	326
R508B	Trifluoromethane, Hexafluoroethane	Dark Blue	302

II. Retrofits and Conversions

- Blend Terminology and Issues 60-83
 - Fractionation
 - Temperature Glide
 - Application Property Match
 - Lubricants

- General Retrofit Guidelines
 - Checklist and Data Sheet 84-85
 - Retrofit Procedures by Product 86-92

Single Components vs. Blends

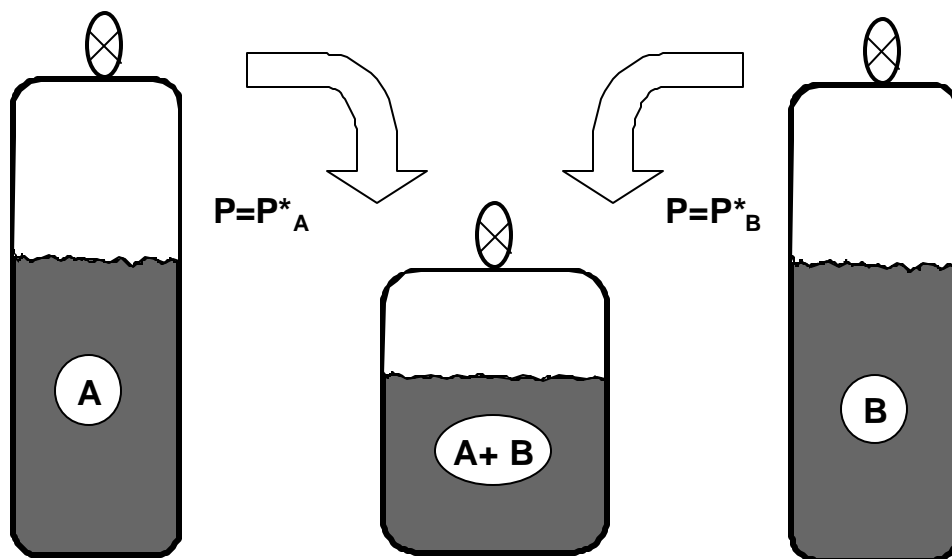

By Convention, Higher Pressure Component is First ($P^*_A > P^*_B$)

Blends are made up of two or more single component refrigerants. One of two situations will occur, depending on how strong the different molecules are attracted to each other:

Azeotrope: a blend that behaves like a single component refrigerant. When a blend forms an azeotrope it displays unique and unexpected properties.

Zeotrope: a blend that behaves like a mixture of the individual components. Zeotropes have predictable properties based on combinations of the pure components' properties.

In addition, it is sometimes helpful to classify some blends as Near-Azeotropes. These blends have predictable blend properties, however the difference between these properties and what is observed for single component refrigerants is not that significant. Many of the problems associated with system operation using a blend will not be noticeable with near-azeotropes.

Two new properties (to be explained soon) are Fractionation and Temperature Glide. We can split the zeotropic blends into Low Fractionation Potential, which also show Low Temperature Glide, and High Fractionation Potential, which also show High Temperature Glide. (Generally speaking blends with less than 5°F glide are considered near-azeotropes).

Pressure Temperature Curves for Refrigerant Blends

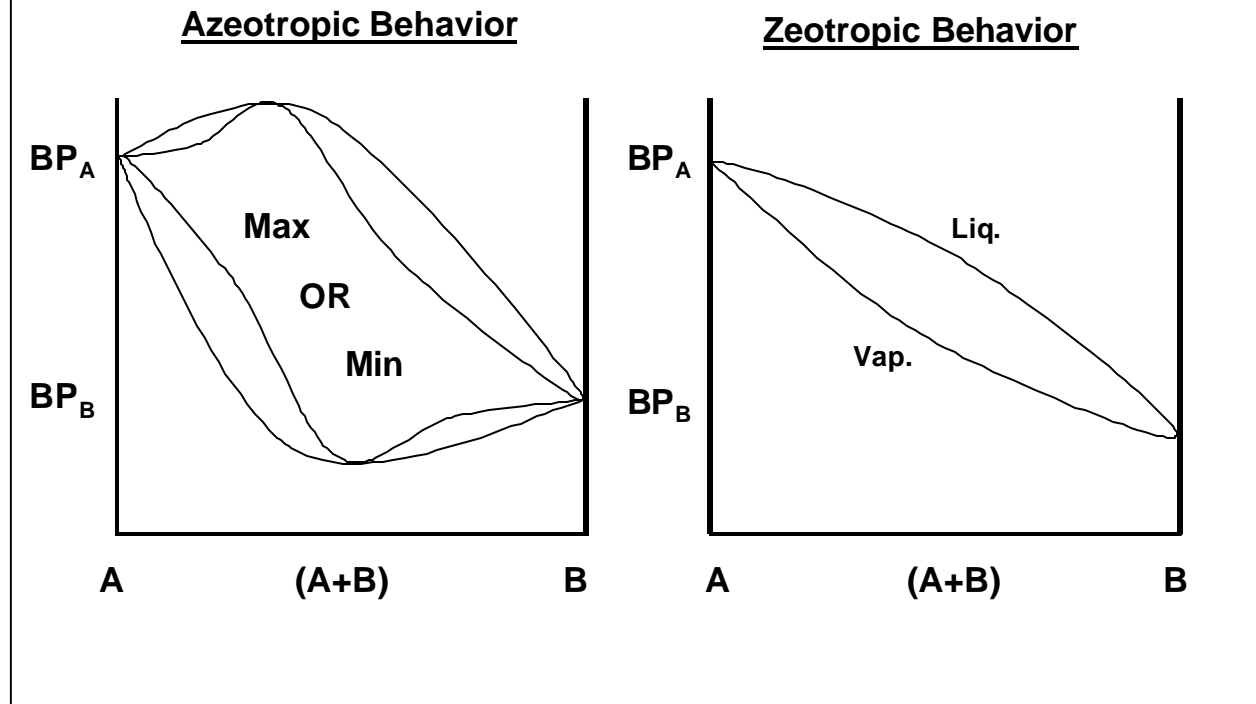

Azeotrope : a special case where the refrigerants combine in a unique way. At the azeotropic composition the blend behaves like a single refrigerant with its own P-T relationship. The pressure after mixing is either higher than the pressures of the individual components, or it is lower than either component. Because the refrigerants are attracted in a special way the vapor in equilibrium with the liquid is at the same composition during phase change.

Note: the azeotropic composition depends on temperature. The same combination of refrigerants may form an azeotrope at a different composition, or not at all, at some other temperature.

Zeotrope : the pressure-temperature relationship is a natural combination of the components' properties. The pressure for the blend falls between the pressures of its components, and can be calculated according to established formulas. Given the P-T relationship for each refrigerant we can calculate the resulting pressure and the vapor composition above the liquid for any given liquid composition.

Introduction to Fractionation: Behavior of Individual Refrigerant Molecules

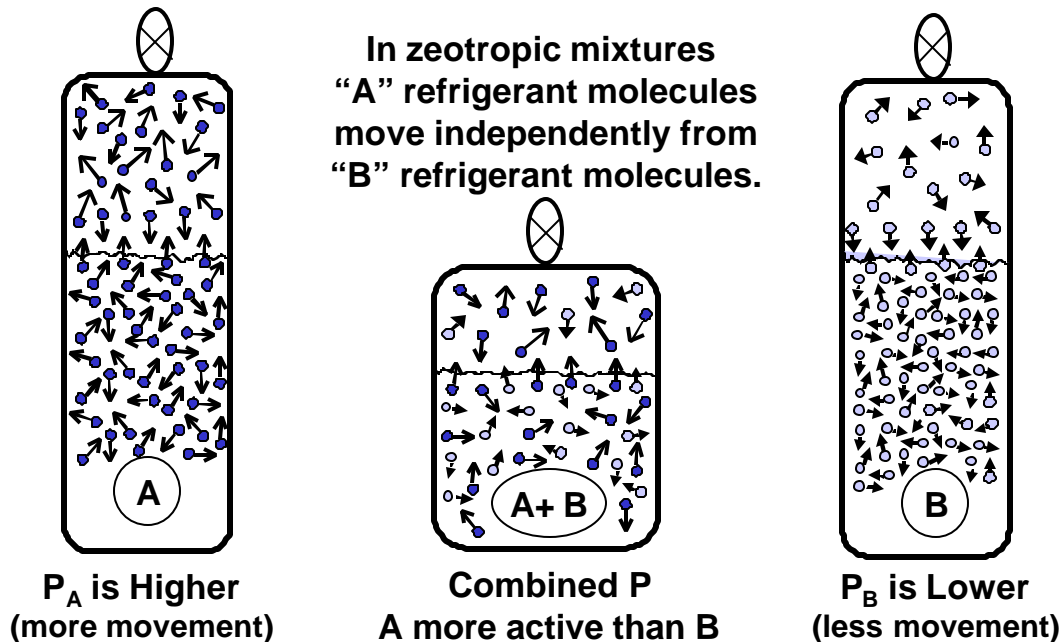

There are two basic behaviors of refrigerant molecules which will help explain why fractionation occurs:

1. Pure refrigerants, A or B, exert pressure on the cylinder (or a system) because the molecules are moving around. At higher temperatures they move around faster, which means more pressure. At lower temperatures there is less movement, so lower pressure.

Different refrigerants have different energies at the same temperature, and therefore generate higher or lower pressures.

2. Molecules of refrigerant are constantly moving from liquid to vapor and vapor to liquid at the surface of the liquid. Vapor and liquid at equilibrium transfer the same number of molecules back and forth; boiling liquid transfers more from liquid to vapor; and condensing vapor transfers more from vapor to liquid.

Different refrigerants transfer back and forth to the vapor at different rates.

When you mix A and B together, and they form a zeotrope, the individual refrigerant molecules behave as if the other type is not there. The As bounce harder than the Bs, contributing more pressure to the blend, but more importantly - *the As transfer back and forth to the vapor faster than the Bs*. This means there are more As in the vapor than there are Bs (we predicted this from our formulas).

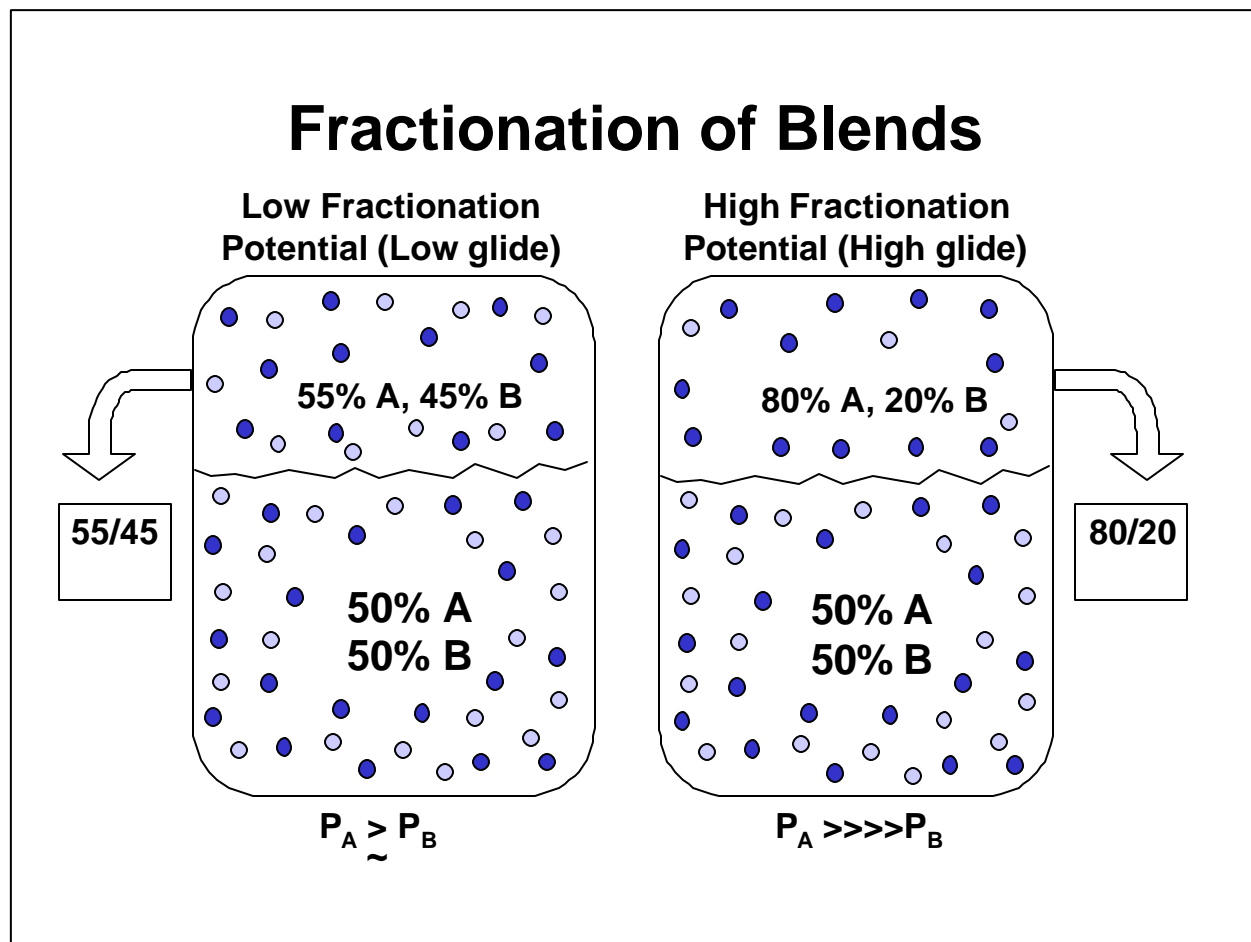

When vapor is removed from a cylinder or system containing a zeotropic blend two things are going to happen: 1) the vapor being removed is at the wrong composition, it will have more of the higher pressure/higher capacity refrigerant component; and 2) the liquid that is left behind boils more of the higher pressure component out of the liquid to replace the vapor. Eventually the liquid composition changes because more of the A component leaves compared to the bulk liquid composition.

FRACTIONATION is the change in composition of a blend because one (or more) of the components is lost or removed faster than the other(s).

The greater the difference between the pressures of the starting components will cause a greater difference in the vapor composition compared to liquid. This will worsen the effect of fractionation on that blend. The High Fractionation Potential blend shown above will produce a vapor composition of 80% A and 20% B above the liquid composition of 50/50.

The closer the individual component pressure become then the more similar the transfer of molecules to the vapor becomes. The Low Fractionation Potential blend shown above will not have that different a vapor composition compared to the liquid. In this case it will take a long time to noticeably change the liquid composition away from 50/50.

Temperature Glide (discussed soon) will be higher for High Fractionation blends, and lower for Low Fractionation blends.

Effects of Fractionation in a Cylinder

- Charge wrong composition - poor system behavior
- Leave behind wrong composition - rest of cylinder no good

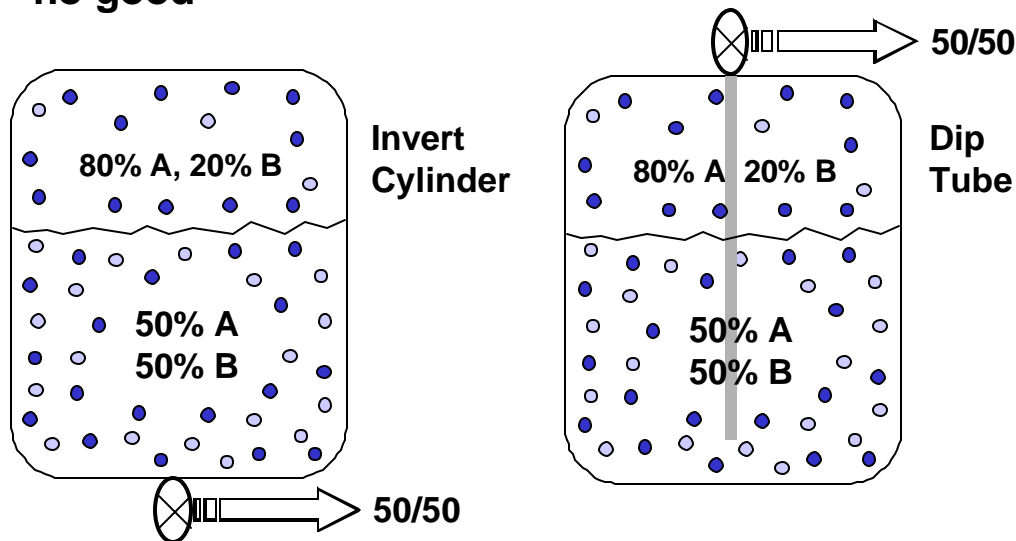

In order to avoid charging the wrong composition and fractionating the remaining blend, zeotropic blends must be *removed from the cylinder as a liquid*. This can be done by turning the cylinder over so the valve is on the bottom, or forcing the product through a dip tube to the valve.

* All of the major manufacturers have removed dip tubes from their “30 lb.” packages as of 1999. There may be some older cylinders, or products from third party packaging companies, that still contain dip tubes. Check the box or cylinder labels for instructions on which side should be up for liquid removal.

Liquid charging does not mean that liquid refrigerant should be pushed into the suction line of the system and it be allowed to slug the compressor. After the initial charge into the high side of a system, the compressor can be started and charging can be completed by flashing the refrigerant from liquid to vapor in the charging hose or across specially designed valves. Any method which allows the refrigerant to go to vapor before it hits the compressor should work. Generally the refrigerant needs to be added slowly at this point.

Fractionation Effects on System Charge

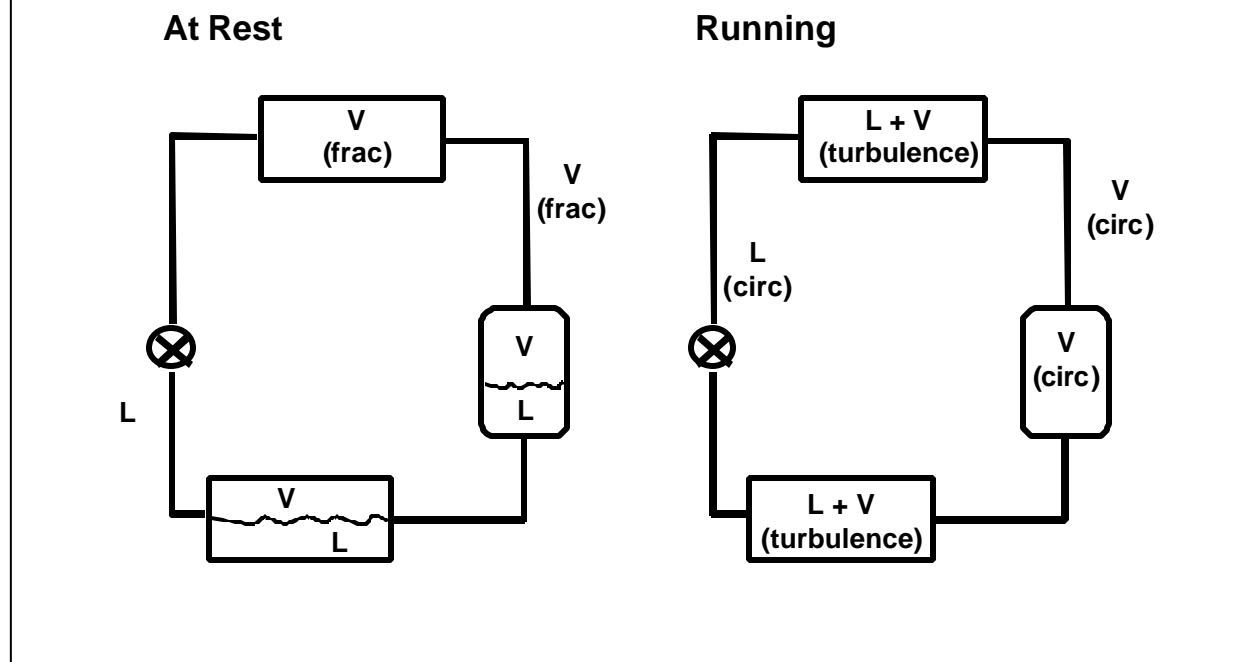

A system at rest will allow the refrigerant to pool and the vapor to come to an equilibrium concentration. Leaks which occur in vapor areas of the equipment will allow fractionation of the blend. The worst case will occur when about half of the refrigerant charge has leaked. (Small amounts leaked from a system will not change the remaining blend by much. Large leaks will shift the composition, but the majority of the pounds after recharge will be from fresh product at the right composition.)

Recharging the system after repair will result in a blend with slightly reduced capacity and operating pressures. In smaller systems, where charge size is critical, it will be best to pull any remaining refrigerant and charge with fresh blend. In larger systems you will need to make a decision whether the remaining charge should be pulled or not. Note: for Low Fractionation Potential blends you will not see much shift in composition anyway, and therefore the charge can be topped off after repair without loss of properties.

In running systems it has been found that the circulating composition is the bulk blend composition. In liquid and suction lines there is no second phase, and in the heat exchangers there is much turbulence so leaks will lose both vapor and liquid. Testing has shown that leaks from a running system do not cause fractionation, and a normally cycling system will not fractionate much on the off cycle.

In other words, in most cases servicing blends does not require full recovery of the charge.

Fractionation Effects on Some System Components

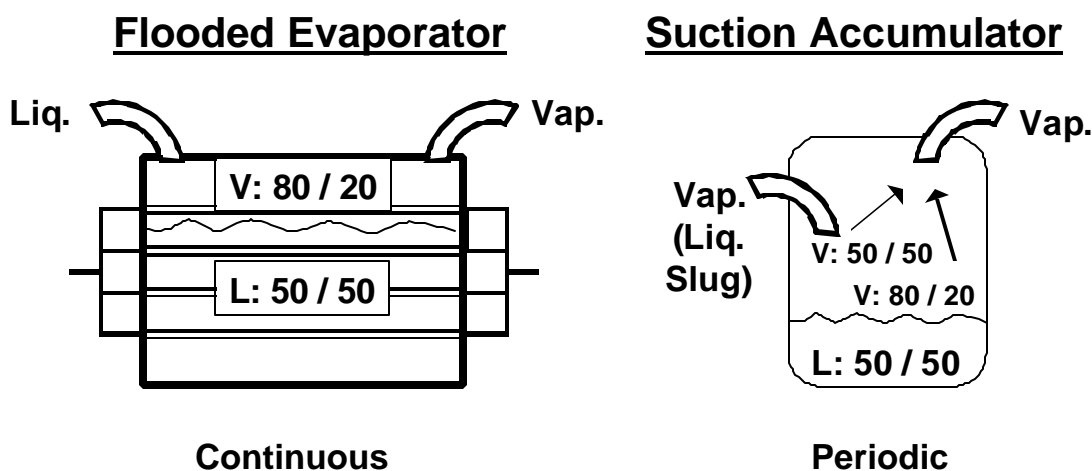

Flooded Evaporators are designed to keep a pool of boiling liquid refrigerant surrounding a bundle of tubes. The water, brine, or product to be cooled flows through the tubes. The vapor which boils off this pool is returned to the compressor, condensed, then poured back into the pool.

In the case of zeotropic blends, the vapor which boils off this pool of refrigerant will be at the fractionated composition. If the properties at this composition differ significantly from what the compressor expects, then the system could develop high head pressures, high amperage draw at the compressor, reduced cooling effectiveness (capacity) in the evaporator, etc. Normally it is not recommended to use blends in this type of system.

Suction Accumulators are placed in the suction line before the compressor to keep liquid from flowing into the compressor. The liquid slug is trapped in the accumulator where it can boil off to vapor, combining with other suction gas. Zeotropic blends will fractionate in the accumulator, giving a short-lived spike of higher pressure vapor back to the compressor.

Systems with suction accumulators should not be overcharged with the expectation that the accumulator will protect the compressor. (This may lead to frequent pressure spikes.) Also, this type of system should never be charged by dumping liquid refrigerant into the suction line and allowing it to vaporize in the accumulator. (High pressure trips may occur.)

Refrigerant Glide in the Evaporator

Relationship between blend fractionation and temperature glide through evaporator tube:

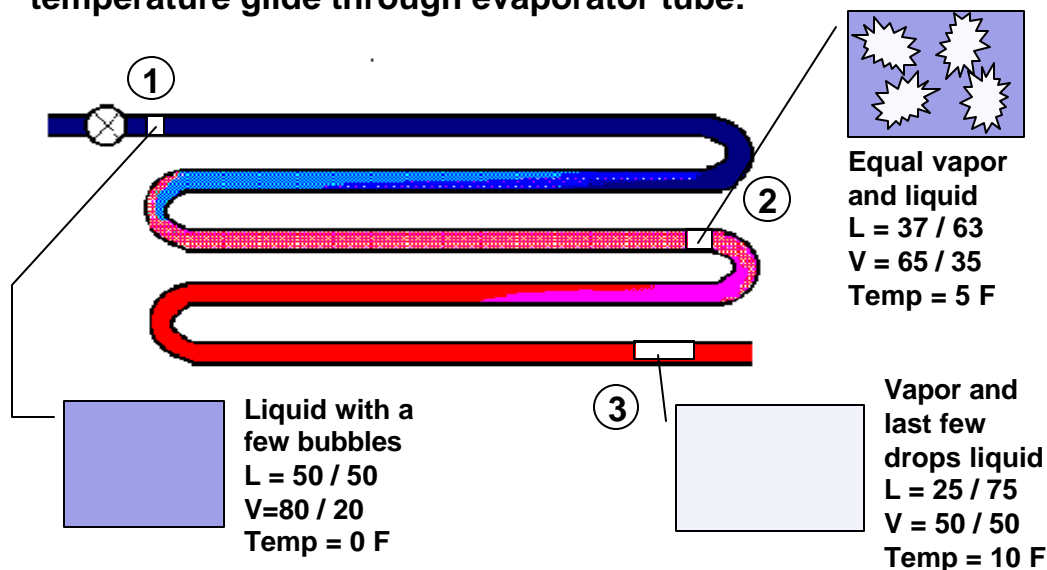

Let's assume that a blend of 50% A and 50% B flows across a valve into an evaporator coil. If we follow a small "piece" of the blend as it flows along the tube we can see the effect of fractionation:

1. At the beginning of the tube the blend is mostly liquid with a few bubbles in it. The liquid composition is 50/50 and the boiling point is (for purposes of discussion) 0°F.
2. As the "piece" of refrigerant marches along the tube more liquid is boiled to vapor. Since A transfers to vapor faster than B, a larger proportion of A (than B) is transferred to vapor. This makes the composition of the liquid change along the length of the tube. In this example the "piece of blend," which started at 50/50, now has a liquid composition at 37% A and 63% B. (Of course the vapor has the extra A - at 65%.) The important point is that the boiling temperature of the current liquid composition is now about 5°F.
3. When our "piece" of the blend gets to the end of the evaporator it is now almost all vapor. This vapor contains almost all of the refrigerant that we started with at the beginning of the tube, so the composition is almost back to 50/50. The last few remaining drops are now concentrated in the B component (about 75% in this example). The boiling point of this liquid composition is now about 10°F.

Overall Temperature Glide : The difference in temperature between the Saturated Vapor blend at the end of the evaporator and the liquid entering the evaporator is 10°F-0°F = 10°F.

Effects of Temperature Glide

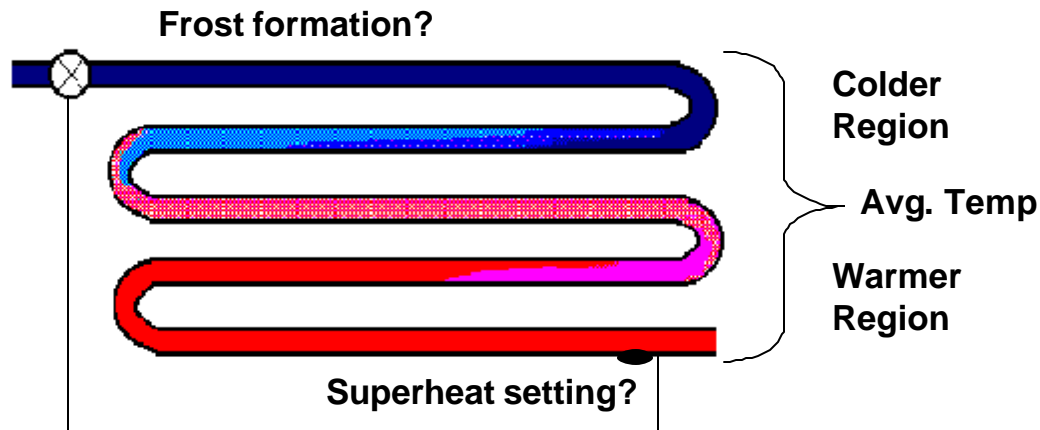

- **Thermostat placement in air stream**
- **Ice machine: ice formation and harvest control setting**

For pure refrigerants the evaporator coil is at a constant temperature throughout. For blends the temperature glide causes the tubing to be at different temperatures.

If you stand back and blow a fan across the evaporator coil, the air which blows out the other side looks like it saw an average evaporator temperature. Part of the evaporator is colder, and part is warmer, but the air mixes and generally gives the equivalent box temperature as if it passes over a constant temperature coil at this average. There are some potential problems which can occur:

- The colder part of the coil may form frost faster than the equivalent one constant temp.
- The warmer part of the coil may cause “hot spots” in the case, affecting product quality?
- Temperature control sensors located in hot or cold spots may affect cycle times.
- Ice machines will produce thicker ice on the bottom coils and thinner ice at the top.
- TXV sensor bulbs are located at the outlet of the evaporator, which now sees warmer gas.

Generally the temperature glide does not affect the system’s ability to remove heat from product, but the glide will probably affect some of the system’s controls. Superheat settings and pressure controls will be discussed further.

Frost formation, hot or cold spots must be addressed “outside” the refrigeration loop (defrost strategies, product placement, etc.).

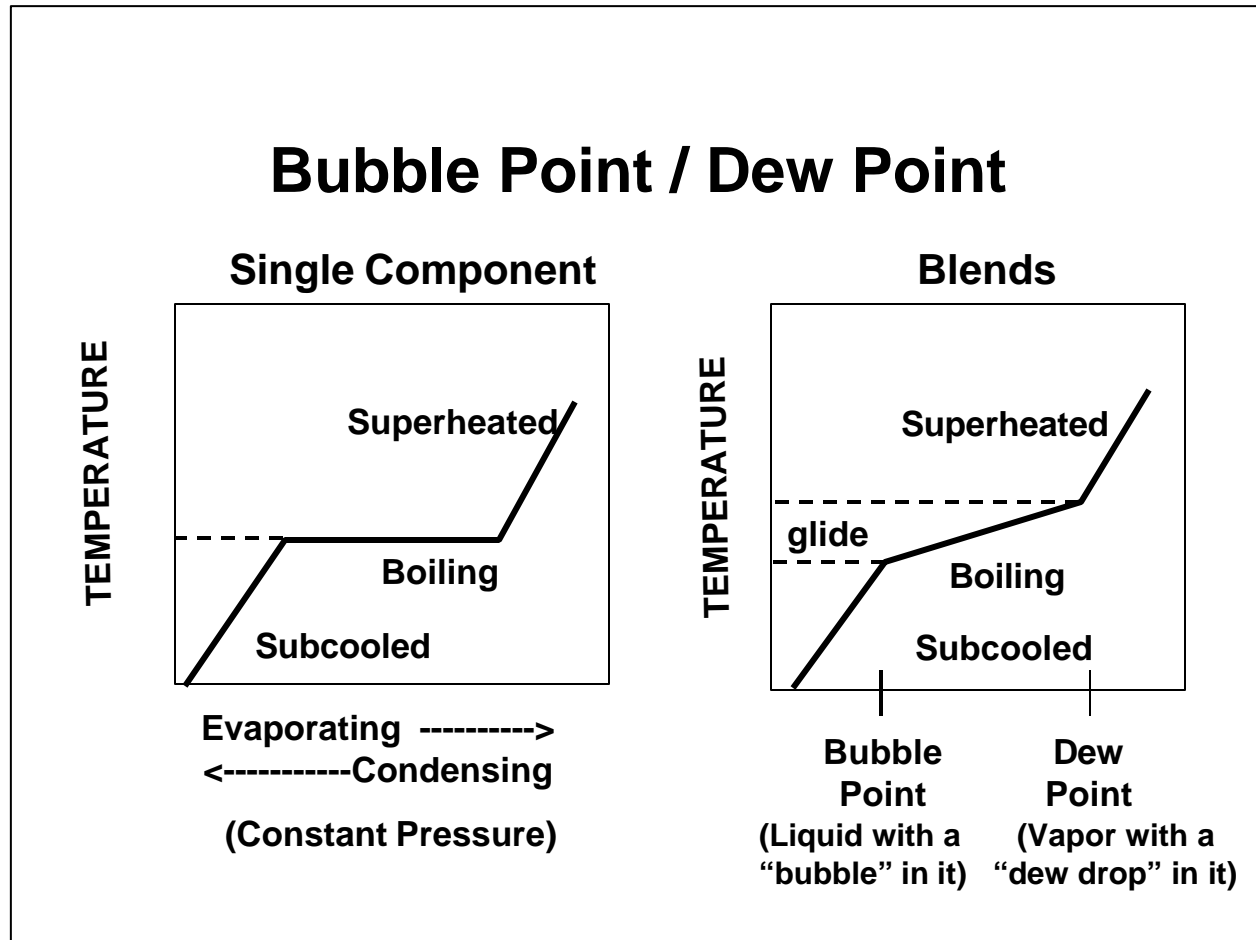

The process of phase change (boiling or condensing) is the same for blends as it is for pure refrigerants:

Boiling: liquid reaches a temperature where bubbles form, then the liquid boils to vapor. When the last drops of liquid disappear, any additional heat input causes the vapor to superheat.

Condensing: vapor cools to a temperature where liquid drops start to form, then the vapor condenses to liquid. When the last of the vapor disappears, any additional removal of heat causes the liquid to subcool.

When these phase changes occur to a pure refrigerant, at constant pressure, the temperature stays constant at what we normally call the “boiling point.”

For blends the process is the same, but the shift in composition during phase change causes the temperature glide to occur. The vapor will still superheat, and the liquid will still subcool, however the Saturated Vapor temperature and the Saturated Liquid temperature are not the same like they were for pure refrigerants. We now must know the particular saturated temperatures at the ends of the temperature glide for a given pressure.

Saturated Liquid = Bubble Point (Liquid with bubbles starting to form)

Saturated Vapor = Dew Point (Vapor with dew drops starting to form)

Two-Column PT Charts

- Traditional PT Charts
 - Temperature on left side, pressure in columns
 - Saturated pressure listed - same for boiling or condensing / saturated liquid or vapor.
- New Blends Need Two Columns
 - Zeotropic blends have different temperatures for saturated liquid and saturated vapor at constant pressure.
 - Bubble Point (or Liquid) gives pressure for saturated liquid. Used as the reference point for subcooling calculations, for example.
 - Dew Point (or Vapor) gives pressure for saturated vapor. Used as the reference point for superheat calculations, for example.

NATIONAL REFRIGERANTS			
T	P	V	L
-10	4.5	1.7	8.7
-5	6.7	3.8	11.4
0	9.2	6.1	14.4
5	11.8	8.6	17.6
10	14.6	11.4	21.1
15	17.7	14.4	24.9
20	21.0	17.6	29.0
25	24.6	21.2	33.4
30	28.5	25.0	38.1
35	32.6	29.2	43.2
40	37.0	33.6	48.6
45	41.7	38.5	54.4
50	46.7	43.6	60.6
55	52.0	49.2	67.2
60	57.7	55.2	74.2
65	63.8	61.5	81.7
70	70.2	68.4	89.6
75	77.0	75.6	98
80	84.2	83.4	107
85	91.8	91.6	116
90	99.8	100	126
95	108.	109	136
100	110	119	147
105	118	130	159
110	122	141	171
115	126	152	184

Pressure-Temperature charts traditionally have listed the temperature in the left column and pressures for various refrigerants in the rest of the columns. For blends we now need two columns, one for Vapor and one for Liquid pressures.

Note: you should not read a PT chart across - heat exchangers run at constant pressure, not constant temperature.

Superheat Setting: the process for obtaining superheat is the same as it has always been - measure the temperature on the suction line, for example at the TXV bulb. To find the saturated vapor temperature you measure the suction pressure, then go to the PT chart for the corresponding temperature. For blends you must use the Vapor (Dew Point) column. Subtract the saturated temperature from the measured temperature to get amt. of superheat.

Subcooling: again the process is the same - measure the temperature of the line at the point of interest. To find the saturated temperature of the liquid you measure the pressure on the condenser, then go to the PT chart for the corresponding temperature. For blends you must use the Liquid (Bubble Point) column. Subtract the measured value from the saturated value to get degrees of subcooling.

Keep in mind the state of the refrigerant where you are measuring - liquid or vapor - to determine which column you need to use.

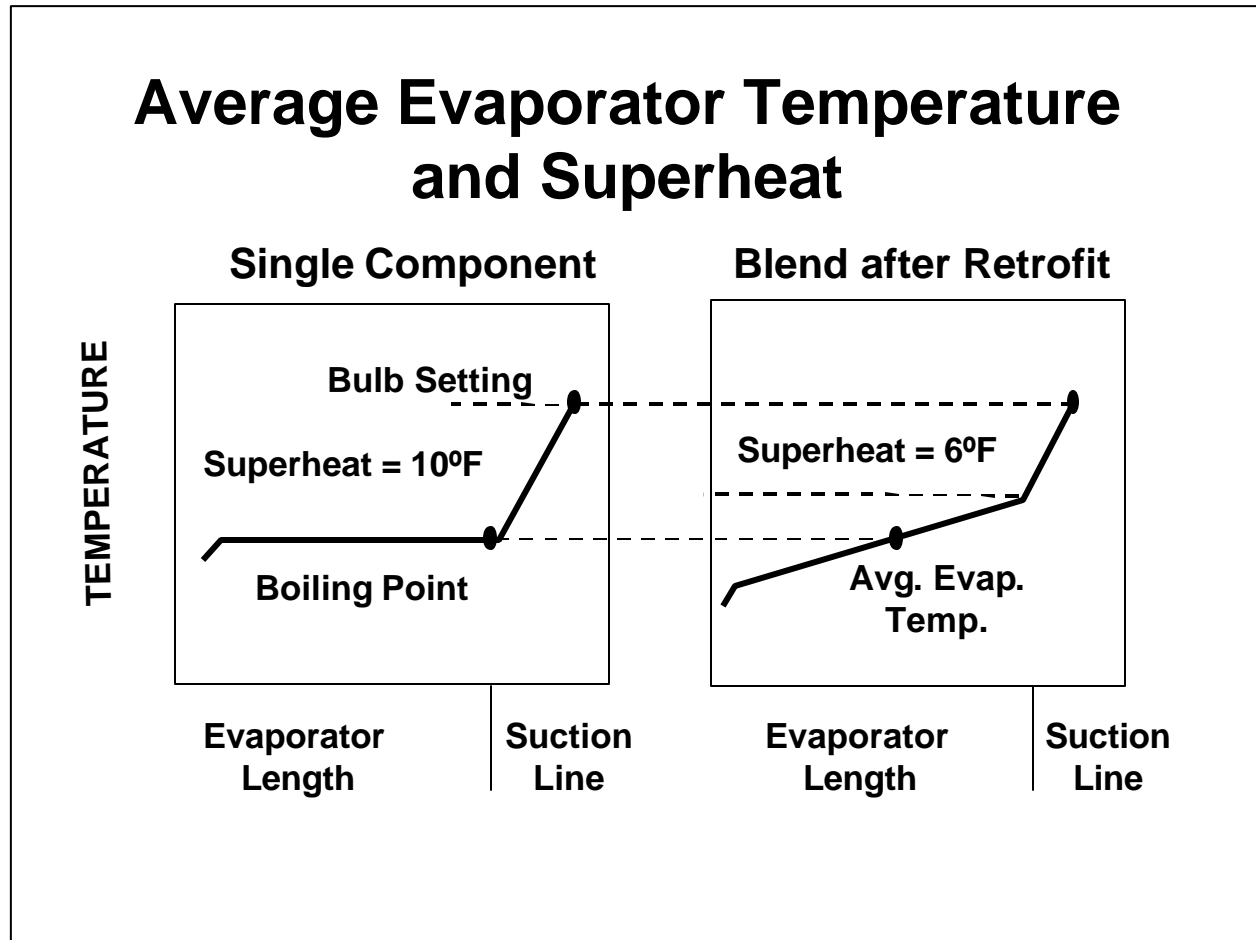

Let's assume we have a blend with a temperature glide of about 8°F. After a retrofit job we have the blend running at a pressure so the average evaporator temperature matches the constant evaporator temperature of the product we replaced. About half of the glide is making the front of the evaporator colder, and the other half of the glide is making the back of the evaporator warmer. The outlet is about 4°F warmer than it used to be.

The TXV bulb has not been adjusted, and it used to be set for 10°F superheat above the saturated temperature of our pure refrigerant. Now, with the blend, it is maintaining the same temperature - but now this only provides 6°F of superheat above the blend's vapor temperature.

If the safety margin provided by the superheat setting is reduced too far it is possible that the refrigerant may flood back to the compressor. In many cases reducing the superheat by 4°F or 5°F may not be a problem, but it is always a good idea to check the superheat to make sure.

Cut In / Cut Out Pressure Control Using Blends

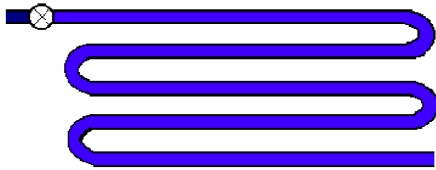
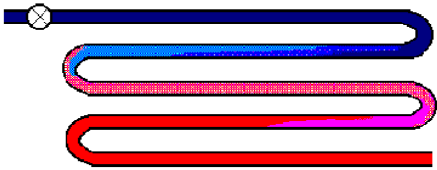
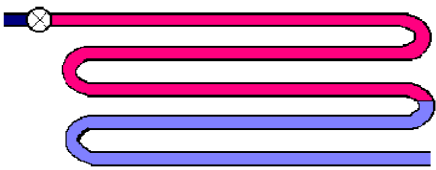
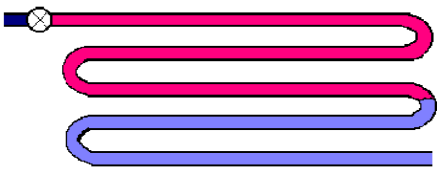
<p style="text-align: center;"><u>R-12: Running System</u></p>  <p style="text-align: center;">Cut Out pressure=15 psig Corresponds to 10°F boiling temp</p>	<p style="text-align: center;"><u>Blend: Running System</u></p>  <p style="text-align: center;">Cut Out pressure=15 psig Corresponds to 10°F avg. evap. temp</p>
<p style="text-align: center;"><u>R-12: System is Off</u></p>  <p style="text-align: center;">Cut In pressure=35 psig Corresponds to 38°F "Liquid Pool" temp</p>	<p style="text-align: center;"><u>Blend: System is Off</u></p>  <p style="text-align: center;">Cut In pressure=45 psig Corresponds to 38°F "Liquid Pool" temp</p>

With a R-12 a Cut In/Cut Out Pressure Controls work as follows:

- The R-12 coil gets down to about 10°F and the pressure is about 15 psig. This means the box temperature is somewhere in the 20's °F. The pressure switch knows the box is cold enough and it turns off the compressor.
- Liquid R-12 pools in the evaporator coil and warms up to box temperature. As the box warms to about 38°F the R-12 in the coil generates 35 psig, and the pressure switch turns the system on again.

With the R-12 Retrofit Blends the control works about the same:

- The average blend coil temperature gets down to about 10°F at about 15 to 16 psig (depending on the blend). The box temperature is about the same as it was with R-12, and the pressure switch shuts off the system.
- LIQUID blend settles in the coil and warms to box temperature. The blends have higher liquid pressures than R-12 - if no adjustment is made the pressure switch will kick the system back on at 35 psig. For 401A this happens at 29°F; for 406A it is 32°F; for 409A it is 27°F; for 414B it is 30°F; and for 416A it is 43°F. Most of the blends will turn the system on too cold, and short cycling will cause the system to freeze up.

You will need to check the liquid pressure at 38°F and reset the cut in pressure accordingly.

New Variable: Composition

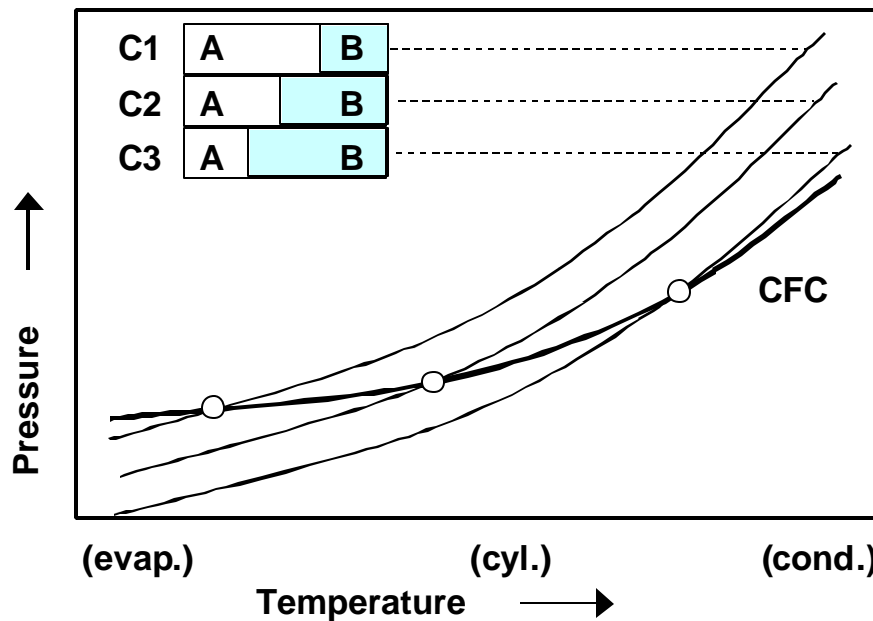

Once you mix a blend at a given composition, the pressure-temperature relationships follow the same general rules as for pure components, for example the pressure goes up when the temperature goes up. For three blends containing different amounts of A and B, the pressure curve is similarly shaped, but in the resulting pressure will be higher for the blend which contains more of the A (higher pressure) component.

Refrigerant blends that are intended to match some other product (R-12, for example) will rarely match the pressure at all points in the desired temperature range. What is more common is the blend will match in one region and the pressures will be different elsewhere.

In the above example the blend with concentration C1 matches the CFC at cold evaporator temperatures, but the pressures run higher at condenser conditions. The blend with composition C2 matches closer to room temperature, and might show the same pressure in a cylinder being stored, for example. The operation pressures at evaporator and condenser temperatures, however, will be somewhat different. Finally, the blend at C3 will generate the same pressures at hot condenser conditions, but the evaporator must run at lower pressures to get the same temperature.

We will see later that the choice of where the blend matches the pressure relationship can solve (or cause) certain retrofit-related problems.

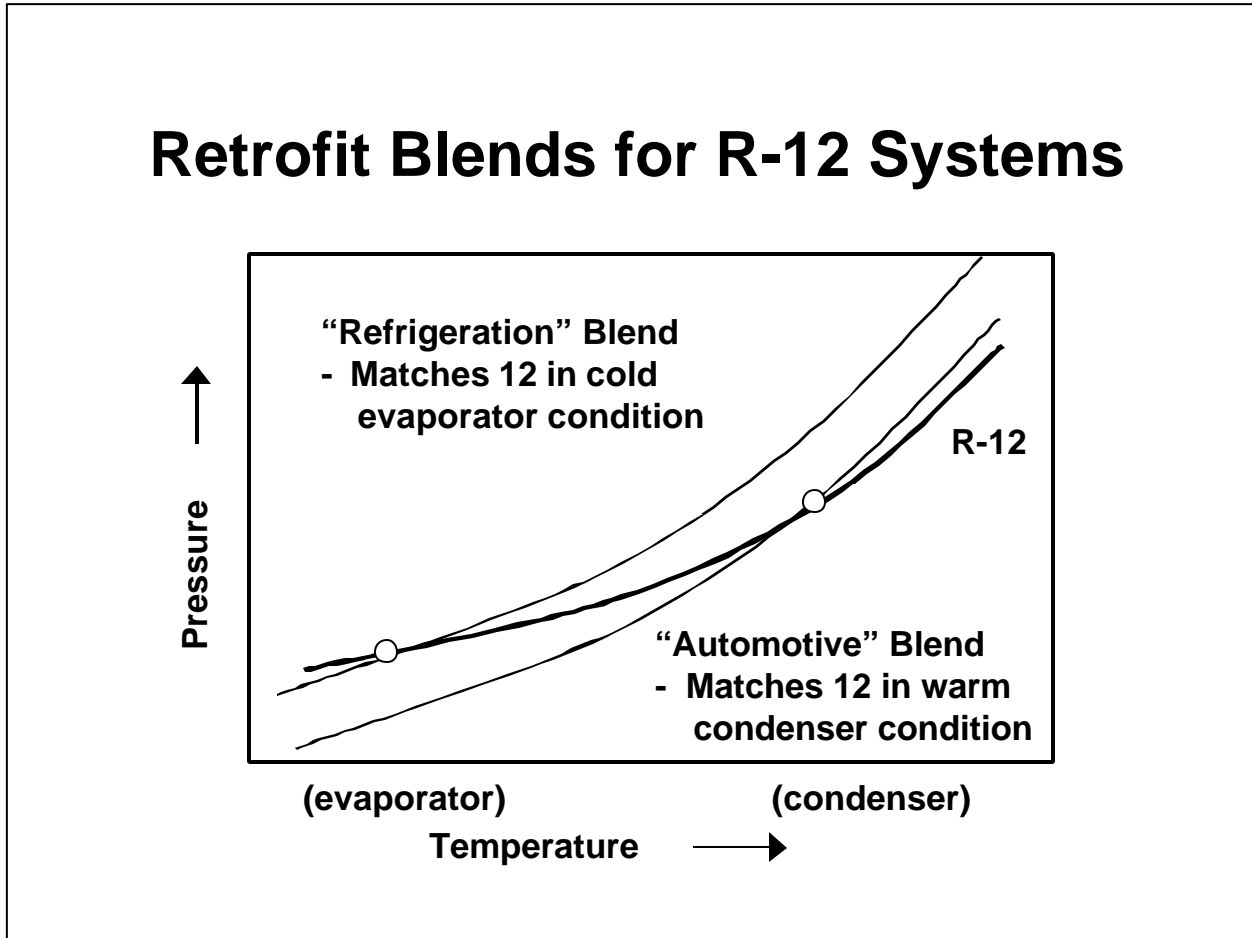

Generally speaking, the R-12 retrofit blends have higher temperature glide and they do not match the pressure/temperature/capacity of R-12 across the wide temperature application range which R-12 was used in the past. In other words, one blend does not fit all.

- Blends which match R-12 at colder evaporator temperatures may generate higher pressures and discharge temperatures when used in warmer applications or in high ambient temperatures. (These are called “Refrigeration Blends”.)

In refrigeration it is often an easier (and cheaper) retrofit job if you can match evaporator pressures to R-12 (and split the glide) because you can get similar box temperatures in similar run times, and probably not need to change controls or TXVs (which are sensitive to pressure).

- Blends which match R-12 properties in hot conditions, like automotive AC condensers, may lose capacity or require lower suction pressures when applied at colder evaporator temperatures. (These are called “Automotive Blends”.)

For automotive air conditioning many of the controls and safety switches are related to the high side pressure. If the blend generates higher discharge pressures you could short cycle more often and lose capacity in general. It is better to pick the high side to match R-12 and let the low side run a little lower pressure.

“R-12” Refrigerants: Property Comparison

Refrigerant	Components	Composition	Glide	Lube	Pressure Match			
					-20	10	40	90F
R-12	(pure)	100	0	M	0.6	14.6	37	100
R-134a	(pure)	100	0	P	4"v	12	35	104
R-401A	22 / 152a / 124	53 / 13 / 34	8	MAP	1	16	42	116
R-401B	22 / 152a / 124	61 / 11 / 28	8	AP	2	19	46	124
R-409A	22 / 124 / 142b	60 / 25 / 15	13	MAP	0	16	40	115
R-414B	22/600a/124/142b	50 / 1.5 / 39 / 9.5	13	MAP	1	16	41	113
R-416A	134a / 600 / 124	59 / 2 / 39	3	P	7.5"v	8	28	88
Freezone	134a / 142b	80 / 20	4	P	6"v	15	31	93

M: Mineral Oil A: Alkyl benzene P: Polyol ester

R-134a: At first look R-134a pressures match R-12 pretty well, but other properties show that 134a needs larger equipment to perform the same job (higher compressor displacement and more surface area in the condenser). In effect R-134a in an R-12 system has lower capacity and higher discharge pressures than expected. In addition it requires POE flushing to remove mineral oil during a retrofit.

R-401A and R-401B: R-22 based blends, which tend to have higher temperature glide. The presence of R-152a, an HFC, hurts oil miscibility with mineral oil. It is recommended to change some of the mineral oil to alkylbenzene unless it is a hermetic system running at warmer temperatures. R-401A matches R-12 capacity at around 20°F evaporator; warmer conditions will begin to show effects from being over-capacity (higher amperage draw, shorter cycle times). The B version offers a boost in capacity at lower temperatures (-30°F).

R-409A: Also R-22 based, with higher temperature glide. It has moderate miscibility with mineral oil, and generally offers good oil return in systems down to 0°F evaporator. R-12 capacity match is about 10°F, and the one composition works well down to lower temperatures. Higher discharge temperatures and pressures can develop, especially in warmer applications.

R-414B: R-22 based (higher temperature glide) but has been blended to keep the head pressure down. It is approved for automotive applications, although nylon barrier hoses and special fittings are required. In refrigeration equipment there may drop in capacity at colder temperatures.

R-416A and Freezone: R-134a based blends, however an HCFC has been added to keep the head pressure lower upon retrofit. There will be a drop in capacity compared to R-12, which could be significant in colder applications. Lower suction pressures must also be taken into account. These blends also have lower temperature glide. The manufacturers claim it is OK to use with mineral oil, however the blends do not actually mix with the oil (return is helped by hydrocarbon components.) POE change is recommended for more complicated piping arrangements.

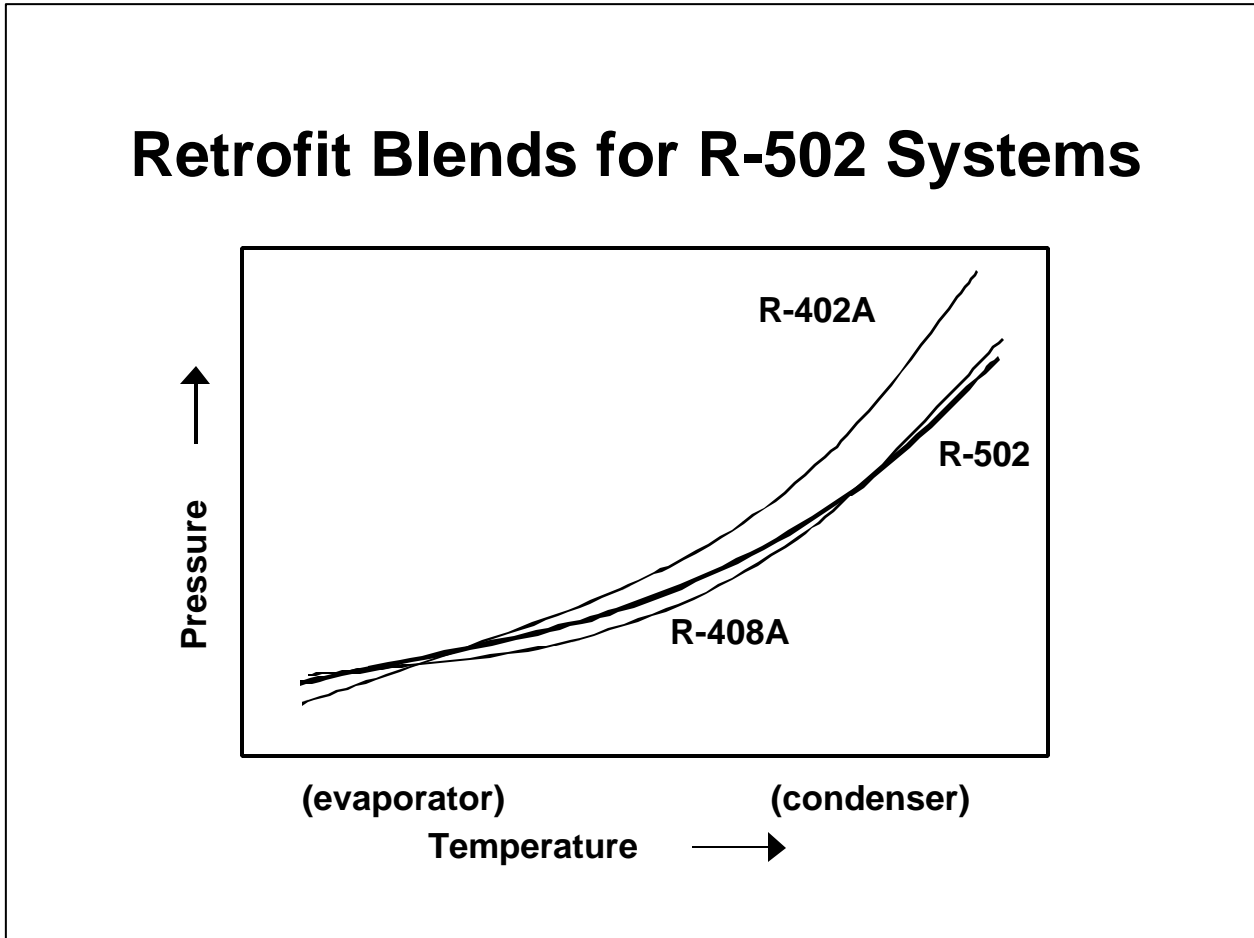

R-502 retrofit blends have much lower temperature glide than the R-12 blends (the components are much closer in their pressure-temperature relationship). Fractionation and glide do not affect the operation of a low temperature refrigeration system using these blends.

The operation of low temperature refrigeration systems depends on a good property match in the evaporator. As a result, all R-502 retrofit blends match evaporator conditions. Some blends develop higher discharge pressures (R-408A matches R-502 very well across the entire pressure-temperature range).

Control settings, valves, etc. generally do not need to be changed or adjusted on the low side of the system. In cases where the discharge pressure is higher, it may be necessary to adjust fan control switches, cooling water controls for water-cooled condensers, and in extreme cases it may be necessary to install pressure relief valves.

“R-502” Refrigerants: Property Comparison

Refrigerant	Components	Composition	Glide	Lube	Pressure Match			
					-20	10	40	90F
R-502	22 / 115	49 / 51	0	MA	15	41	81	187
Retrofit Blends								
R-402A	125 / 290 / 22	60 / 2 / 38	2.5	M+AP	19	48	93	215
R-402B	125 / 290 / 22	38 / 2 / 60	2.5	M+AP	15	42	83	198
R-408A	125 / 143a / 22	7 / 46 / 47	1	M+AP	14	38	77	186
HFC Blends								
R-404A	125 / 143a / 134a	44 / 52 / 4	1.5	P	16	48	84	202
R-507	125 / 143a	50 / 50	0	P	18	46	89	210

M: Mineral Oil A: Alkyl benzene P: Polyol ester

R-402A and R-402B: R-402A shows higher discharge pressures than 502, however the discharge temperature is lower. The B version is a closer match in pressure, but the discharge temperature runs higher (this is good for ice machines, which is where 402B is primarily used). Although propane is added to improve oil circulation, it is still recommended to change some mineral oil over to alkylbenzene.

R-408A: Has the closest PT match to 502 across the whole application range. It also has very low temperature glide. R-408A does generate higher discharge temperatures than 502, and this could be a problem in extreme application conditions, such as transport refrigeration in hot climates. For the most part it can be used in most refrigeration systems.

R-404A and R-507: These two blends are virtually the same in terms of operation and equipment. In a retrofit situation they will require POE flushing to be performed. They will also generate higher discharge pressures. Generally speaking, retrofitting with these HFC blends will add more complexity and cost to a retrofit job, especially comparing them to using one of the other available HCFC based blends.

Retrofitting with HFCs

- **Lubricant Compatibility**
 - Existing systems with mineral oil or AB must be flushed and filled with POE
 - Concern over POE reactivity with residual contaminants
- **Material Compatibility**
 - Hoses, gaskets, seals, etc. may show leakage, swelling, degradation
- **Performance**
 - Capacity or heat transfer differences may affect systems ability to do the job

Lubricant Compatibility: HFC refrigerants will not mix with mineral oil or alkylbenzene. When retrofitting an existing system to an HFC it will be necessary to flush the old oil out of the system and replace it with polyol ester. If the residual level of non-POE is above 5%, then pockets of oil may drop out of the refrigerant and coat tubing, take up space, or clog openings inside the system.

In addition to the question of mixing, there are concerns over the chemical reactivity of POEs in the presence of residual oils and contaminants left in the system. POEs are also better solvents than previous lubricants, and systems with residue on the inside of piping or components may be “cleaned” by the POE, which will now circulate the impurities to the valve and/or compressor.

Material Compatibility: Rubber seals or gaskets which worked well with CFCs or HCFCs may have a problem with HFCs and ester oils. If the chemical makeup of the rubber is similar to the HFC or POE, these new fluids may soak into the rubber (or leach out material from the rubber) and cause the seal to swell (or shrink) out of the gap to be sealed. It is possible that leakage will not show up until several weeks after the retrofit job is over.

Performance: HFC refrigerants do not match the products they replace as well as some retrofit blends will. The pressure, amperage draw, capacity, etc. should be considered when starting up the system after retrofit.

Lubricant Types

- **Mineral Oil (MO):** Refined petroleum product, straight or branched chain hydrocarbons. Non-polar chemistry means they mix well with CFCs, OK with HCFCs, not with HFCs.
- **Alkyl Benzene (AB):** Synthetic lubricant made to act like mineral oil, long chain hydrocarbons with closed rings. Somewhat polar - better HCFC miscibility.
- **PAG:** Poly Alkaline Glycol, long chain hydrocarbons with alcohol functions. OK for HFC, used by auto AC manufacturers (available earlier than POE).
- **Polyol Esters (POE):** Synthetic lubricants with ester functions in the middle of long chain hydrocarbons. More polar so they mix better with HFCs.

Mineral Oil: Byproduct of petroleum processing - so it is cheap. It has been used a long time and the industry has gained a lot of experience, and solved a lot of problems associated with using it. Unfortunately the chemical makeup causes mineral oil to mix very little with the new HFCs.

Alkyl Benzene: Special process in a different part of the petroleum plant - so it is relatively cheap. It has been used either in colder applications, where it mixes better with HCFCs than mineral oil, or in high abuse areas, since it is somewhat more stable at high temperatures compared to mineral oil. It also will not mix with the new HFCs.

Poly Alkaline Glycols: Created chemical which is slippery like oil but has chemical functions which make it polar - so it will mix with HFCs. PAGs were adopted by the automotive AC industry because they were available and worked OK in those systems. Stationary AC and refrigeration manufacturers had more problems applying PAGs so they waited for development of the POEs instead.

Polyol Esters: Created chemicals which have a different type of chemical function which makes them polar - so they can mix with HFCs better at colder temperatures. The lighter grades have better properties than PAGs, so they have been adopted by most stationary refrigeration and AC equipment manufacturers.

Lubricant Recommendations for Blends Properties to Consider

- **Viscosity:** What is the resistance to flow? Is it the right thickness for the equipment?
- **Lubricity:** How well is the compressor protected? (Resistance to wear)
- **Chemical Compatibility:** Are there any reactions going on?
- **Miscibility:** At a given temperature, will the lubricant mix with the refrigerant, or form a separate oil-rich layer? (sticks to piping, does not return to compressor)
- **Solubility:** How much refrigerant can be absorbed and held in the oil during normal operation? (can affect lubricant properties if thinned by refrigerant)

Lubricant properties can be evaluated to determine if the product is right for the job. Three basic properties, Viscosity, Lubricity, and Chemical Stability, must be satisfactory to protect the compressor.

- The correct viscosity is needed to fill the gaps between parts and flow correctly where it is supposed to go. Generally speaking, smaller equipment with smaller gaps between moving parts requires a lighter viscosity, and larger equipment with bigger parts needs heavier viscosity oils.
- Lubricity refers to the lubricant's ability to protect the metal surfaces from wear.
- Good Chemical Stability means the lubricant will not react to form harmful chemicals (acids, etc.), sludges which might block tubing, or carbon deposits.

The interaction of lubricant and refrigerant can cause potential problems as well.

- Miscibility defines the temperature region where refrigerant and oil will mix or separate. If there is separation of the oil from the refrigerant in the compressor it is possible that the oil is not getting to metal parts which need it. If there is separation in the evaporator or other parts of the system it is possible that the oil does not return to the compressor and eventually there is not enough oil to protect it.
- Solubility determines if the refrigerant will thin the oil out too much, losing its ability to protect the compressor. The thinning effect also influences oil return.

Water Absorption into Lubricants

Exposure of Lubricant to Moist Air
(PPM Water Absorbed over time)

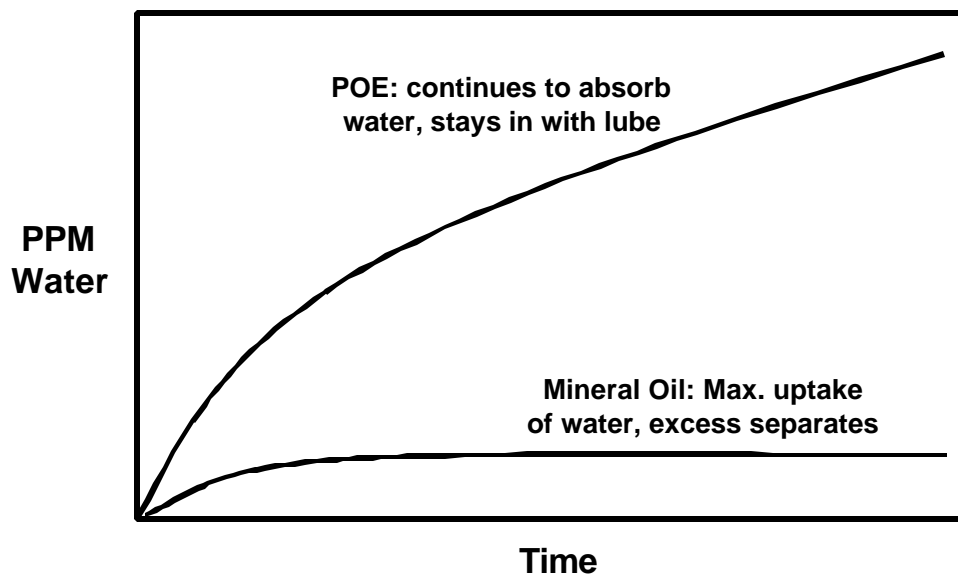

POE lubricants are hygroscopic, which means they like to absorb water. Mineral oils will typically absorb water until they become saturated, then you can't get any more water to mix. Excess water will form a separate layer and potentially freeze in colder parts of the system, perhaps blocking the valve, etc. With POE systems, however, much more water can be absorbed into solution. Tens of thousands of parts per million can be absorbed and still not separate from the refrigerant/oil. This absorbed water can cause breakdown of the POE and other water/acid related problems.

Drying wet POE systems is extremely difficult. The typical "vacuum dry" method will not necessarily work if the water has been absorbed into the POE. Though it will dry up "free" water, even the best vacuum will take a very long time to pull the water molecules away from the lubricant molecules. In this case it is best to close up the system and charge with the proper refrigerant. The refrigerant should pull the water out of the POE and circulate it through the filter/dryer.

Most commercially available driers today have increased amounts of desiccant to protect HFC/POE systems.

Retrofitting: Concern for Oil Return

Decision to Change Type of Oil

2. Oil mixes with hot refrigerant liquid and goes where it goes.

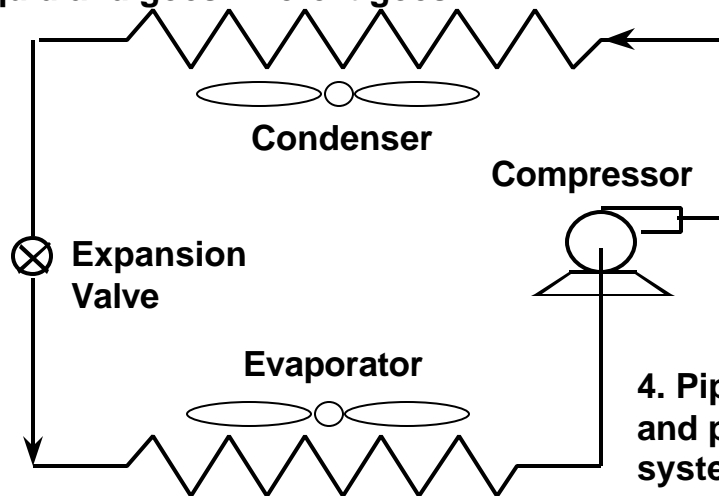

1. Oil leaves compressor in small amts with refrigerant vapor.

4. Piping practices and physical layout of system take over oil return in suction line.

3. Hopefully, oil mixes with cold refrigerant and goes out of evap.

Most refrigeration and air conditioning systems are designed to depend on mixing of the oil and refrigerant:

- In the compressor the oil must lubricate parts throughout, and separation of oil and refrigerant would keep the oil away from parts located where liquid refrigerant might pool.
- Some of the oil, which is lubricating the piston or rotor seal, will be blown out of the compressor with the refrigerant, and the question of whether this oil gets back to the compressor often depends on how well it mixes with the circulating refrigerant.
- Oil that separates from the refrigerant could stick to piping and reduce heat transfer (in addition to not getting back to the compressor).

The question of whether to change oil when retrofitting is tied directly to oil return within the system. The main properties to look at are oil miscibility and solubility. Miscibility relationships show whether the oil and refrigerant will mix at the expected system temperatures. Solubility will indicate if refrigerant will thin the oil enough to move it back to the compressor through the suction tubing.

HFC Retrofitting: POE Oil Flushes

Example of Residual Mineral Oil in POE after Flushing

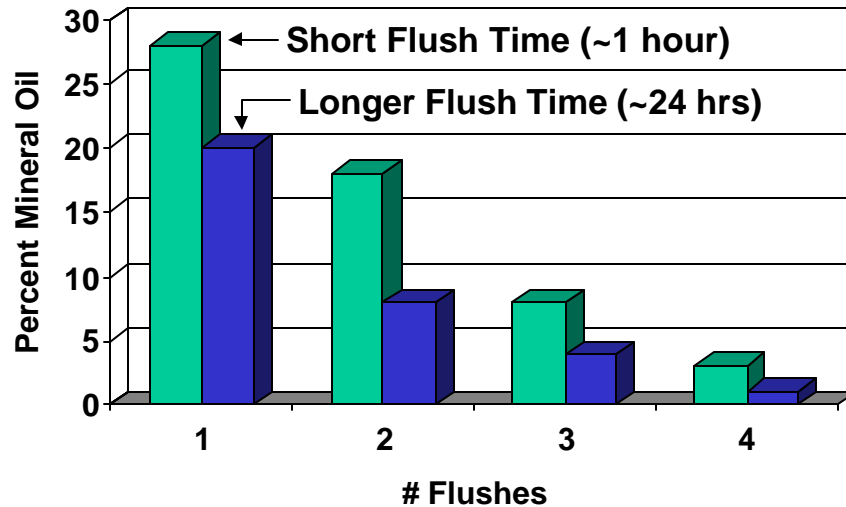

Retrofitting a mineral oil or alkylbenzene system to an HFC refrigerant will require changing as much of the oil to POE as possible. The procedure is generally referred to as “flushing,” and the most common method is to change the compressor oil, run the system, and repeat until the residual mineral oil percentage is sufficiently low.

Accepted industry guidelines suggest the mineral oil or alkylbenzene content in POE be lower than 5%. (Test kits or refractometers are used.) Higher levels can cause small pockets of oil to form, which may interfere with heat transfer or clog tubing or valves, etc.

Flushing is generally more effective if the system runs longer between oil changes. This allows more residual oil to be “picked up” by the circulating POE and brought back to the compressor. Flushing is also generally more effective if done before the refrigerant is changed, rather than after. The original refrigerant promotes better circulation of the original oil. (In many cases the retrofit is not performed until the system breaks down, and therefore the new refrigerant is used after the repair is complete. Planning an HFC retrofit ahead of time makes for easier oil flushing.)

Finally, the POE lubricants used for HFCs are much better solvents than the other oils. Residue on the inside of the system tubing and components can be loosened by the POE and circulated through the valve, cap tube, or compressor causing blockage or damage. A final oil change and filter replacement at the end of the job can reduce this problem.

Refrigerant Retrofit Checklist

System or Circuit Designation:

	Existing System Conditions	Retrofit System Conditions	Retrofit System Conditions	Retrofit System Conditions
DATE/TIME				
AMBIENT TEMP./RH				
REFRIGERANT				
LUBRICANT CHARGE/TYPE				
COMPRESSOR - MODEL				
SUCTION TEMP.				
SUCTION PRESS.				
DISCHARGE TEMP.				
DISCHARGE PRESS.				
MOTOR AMPS/VOLTS				
CONDENSER - MODEL				
COIL AIR/H2O INLET TEMP.				
COIL AIR/H2O OUTLET TEMP.				
REFRIGERANT INLET TEMP.				
REFRIGERANT OUTLET TEMP.				
EVAPORATOR - MODEL				
COOL AIR/H2O INLET TEMP.				
COOL AIR/H2O OUTLET TEMP.				
REFRIGERANT INLET TEMP.				
REFRIGERANT OUTLET TEMP.				
SUPERHEAT SETTING				
EXP. DEVICE # TURNS				
FIXTURE TEMPERATURE				
SIGHT GLASS APPEARANCE				
NOTES				

System Conversion Data Sheet

		EXISTING REFRIGERANT	NEW REFRIGERANT
SYSTEM/CIRCUIT NAME			
SUCTION TEMPERATURE			
CONDENSING TEMPERATURE			
FIXTURE TEMPERATURE			
SYSTEM/CIRC CAPACITY	(Btu/H)		
COMPRESSOR OR CONDENSING UNIT	Manufacturer		
	Model #		
	Serial #		
CONDENSER	Manufacturer		
	Model #		
	Design TD		
RECEIVER	Manufacturer		
	Model #		
	PRV Model#		
	Rating		
HEAD PRESSURE CONTROL	Manufacturer Model # & Size		
EVAPORATOR PRESSURE REGULATING VALVE	Manufacturer Model # & Size		
DISCHARGE BYPASS VALVE	Manufacturer Model # & Size		
HOT GAS SOLOINOID VALVE	Manufacturer Model # & Size		
CRANKCASE PRESSURE REGULATING VALVE	Manufacturer Model # & Size		
LIQUID LINE SOLOINOID VALVE	Manufacturer Model # & Size		
HIGH/LOW PRESSURE CONTROL	Manufacturer Model # & Size		
FILTER/DRIER	Manufacturer		
	Model # & Size		
EXPANSION VALVE	Manufacturer		
	Model # & Size		
EVAPORATOR	Manufacturer		
	Model #		
	Circuits		
	Distributor/nozzle		
LINE SIZING	(Size & Length)		
	Suction Line (horiz)		
	Suction Line (riser)		
	Liquid Line		
NOTES			

R-12 Systems – General Considerations

R-12 and R-500 Air Conditioning

1. For centrifugal compressors it is recommended that the manufacturer's engineering staff become involved in the project – special parts or procedures may be required. This will ensure proper capacity and reliable operation after the retrofit.
2. Most older, direct expansion systems can be retrofit to R-401A, R-409A, R-414B or R-416A (R-500 to R-401B or R-409A), so long as there are no components that will cause fractionation within the system to occur.
3. Filter driers should be changed at the time of conversion.
4. System should be properly labelled with refrigerant and lubricant type.

R-12 Medium / High Temperature Refrigeration (>0F evap)

1. See Recommendation Table for blends that work better in high ambient heat conditions.
2. Review the properties of the new refrigerant you will use, and compare them to R-12. Prepare for any adjustments to system components based on pressure difference or temperature glide.
3. Filter driers should be changed at the time of conversion.
4. System should be properly labelled with refrigerant and lubricant type.

R-12 Low Temperature Refrigeration (<20F evap)

1. See Recommendation Table for blends that have better low temperature capacity.
2. Review the properties of the new refrigerant you will use, and compare them to R-12. Prepare for any adjustments to system components based on pressure difference or temperature glide.
3. Filter driers should be changed at the time of conversion.
4. System should be properly labelled with refrigerant and lubricant type.

Recommendations for R-12 Retrofit Products

Closest Match/Easiest

	R-12 AC	R-500 AC	R-12 small equipment		R-12 larger equipment	
			Higher T	Lower T	Higher T	Lower T
↑	R-414B	R-409A	R-414B	R-409A	R-414B	R-409A
	R-416A	R-401B	R-416A	R-401A	R-409A	R-401A
	R-401A	R-401A	R-401A	R-414B	R-401A	R-414B
	R-409A	R-414B	R-409A	R-416A	R-416A	R-416A
	R-134a	R-134a	R-134a	R-134a	R-134a	R-134a
↓		R-416A				

Poorest Match/Most Difficult

General Retrofit Procedure: Centrifugal, Reciprocating AC and Refrigeration Systems

1. If the system is able to run – collect system data and operating conditions prior to retrofit.
2. Isolate the compressor and recover the R-12. Change the lubricant in the compressor to polyol ester (POE). For hermetic compressors this may require removal of the compressor.
3. Replace any oil in auxilliary components such as oil separators or oil feed systems.
4. Close the system and run with R-12 for 24 hours to circulate the POE and flush the mineral oil back to the compressor.
5. Repeat steps 1-4 until residual mineral oil level is below 5%. (If the unit is not operational then perform the oil flushing procedure immediately after startup with R-134a.)
6. Recover the R-12 from the entire system.
7. Perform any maintenance, repair or component replacements, and change filter/driers.
8. Evacuate the system to manufacturer's specifications.
9. Charge the system with the proper amount of R-134a (usually 85% to 90% of the original R-12 charge by weight).
10. Operate the system and record new system operation data. Make adjustments to controls as needed to ensure proper operation.
11. Label the system with the new refrigerant and lubricant type.

Most Common Areas that Require Adjustment or Attention:

- Changing the lubricant to POE
- TXV valve adjustment / superheat setting

General Retrofit Procedure: Reciprocating AC and Refrigeration Systems

1. If the system is able to run – collect system data and operating conditions prior to retrofit.
2. Recover the R-12 from the entire system.
3. Perform any maintenance, repair or component replacements, and change filter/driers. If needed (for low temperatures) remove mineral oil from the system and replace with an equivalent amount of alkylbenzene oil.
4. Evacuate the system to manufacturer's specifications.
5. Charge the system with the proper amount of the blend (usually 80% to 85% of the original R-12 charge by weight). Be sure to remove liquid refrigerant from the cylinder to get the proper composition (but flash the refrigerant before feeding into a running system).
6. Operate the system and record new system operation data. Make adjustments to controls as needed to ensure proper operation.
7. Label the system with the new refrigerant and lubricant type.

Most Common Areas that Require Adjustment or Attention:

- TXV valve adjustment / superheat setting (use Vapor side of PT chart)
- Pressure controls (cut in / cut out)
- Pressure related switches or controls – difference from R-12 pressures
- Irregular frost formation with high glide blends
- High discharge pressure or temperature, high amps in high ambient temperature conditions (abuse of compressor)

General Retrofit Procedure: Reciprocating AC and Refrigeration Systems

1. If the system is able to run – collect system data and operating conditions prior to retrofit.
2. Recover the R-12 from the entire system.
3. Perform any maintenance, repair or component replacements, and change filter/driers. If needed (for complicated piping, large hold-up volumes) remove mineral oil from the system and replace with an equivalent amount of polyol ester lubricant.
4. Evacuate the system to manufacturer's specifications.
5. Charge the system with the proper amount of the blend (usually 80% to 85% of the original R-12 charge by weight). Be sure to remove liquid refrigerant from the cylinder to get the proper composition (but flash the refrigerant before feeding into a running system).
6. Operate the system and record new system operation data. Make adjustments to controls as needed to ensure proper operation.
7. Label the system with the new refrigerant and lubricant type.

Most Common Areas that Require Adjustment or Attention:

- TXV valve adjustment / superheat setting (use Vapor side of PT chart)
- Pressure controls (cut in / cut out)
- Pressure related switches or controls – lower than R-12 pressures
- Loss of capacity at lower evaporator temperatures / longer run times

General Retrofit Procedure: AC and Refrigeration Systems

1. If the system is able to run – collect system data and operating conditions prior to retrofit.
2. If an oil change is indicated (R-407C, possible R-417A), isolate the compressor and recover the R-22. Change the lubricant in the compressor to polyol ester (POE). For hermetic compressors this may require removal of the compressor.
3. Replace any oil in auxilliary components such as oil separators or oil feed systems.
4. Close the system and run with R-22 for 24 hours to circulate the POE and flush the mineral oil back to the compressor.
5. Repeat steps 1-4 until residual mineral oil level is below 5%. (If the unit is not operational then perform the oil flushing procedure immediately after startup.
6. Recover the R-22 from the entire system.
7. Perform any maintenance, repair or component replacements, and change filter/driers.
8. Evacuate the system to manufacturer's specifications.
9. Charge the system with the proper amount of the blend (usually 85% to 95% of the original R-22 charge by weight). Be sure to remove liquid refrigerant from the cylinder to get the proper composition (but flash the refrigerant before feeding into a running system).
10. Operate the system and record new system operation data. Make adjustments to controls as needed to ensure proper operation.
11. Label the system with the new refrigerant and lubricant type.

Most Common Areas that Require Adjustment or Attention:

- TXV valve adjustment / superheat setting (use Vapor side of PT chart)
- Pressure controls (cut in / cut out)
- Pressure related switches or controls – difference from R-22 pressures
- Irregular frost formation with high glide blends
- Changing the lubricant to POE

General Retrofit Procedure: Reciprocating AC and Transport Refrigeration Systems

1. If the system is able to run – collect system data and operating conditions prior to retrofit.
2. Recover the R-500 from the entire system.
3. Perform any maintenance, repair or component replacements, and change filter/driers. If needed (for low temperatures) remove mineral oil from the system and replace with an equivalent amount of alkylbenzene oil.
4. Evacuate the system to manufacturer's specifications.
5. Charge the system with the proper amount of the blend (usually 85% to 90% of the original R-500 charge by weight). Be sure to remove liquid refrigerant from the cylinder to get the proper composition (but flash the refrigerant before feeding into a running system).
6. Operate the system and record new system operation data. Make adjustments to controls as needed to ensure proper operation.
7. Label the system with the new refrigerant and lubricant type.

Most Common Areas that Require Adjustment or Attention:

- TXV valve adjustment / superheat setting (use Vapor side of PT chart)
- Pressure related switches or controls – most have lower pressure than R-500

General Retrofit Procedure: Refrigeration Systems and Ice Machines

1. If the system is able to run – collect system data and operating conditions prior to retrofit.
2. Recover the R-502 from the entire system.
3. Perform any maintenance, repair or component replacements, and change filter/driers. If oil return has been a problem with R-502, remove mineral oil from the system and replace with an equivalent amount of alkylbenzene oil.
4. Evacuate the system to manufacturer's specifications.
5. Charge the system with the proper amount of the blend (usually 80% to 85% of the original R-502 charge by weight). Be sure to remove liquid refrigerant from the cylinder to get the proper composition (but flash the refrigerant before feeding into a running system).
6. Operate the system and record new system operation data. Make adjustments to controls as needed to ensure proper operation.
7. Label the system with the new refrigerant and lubricant type.

Most Common Areas that Require Adjustment or Attention:

- TXV valve adjustment / superheat setting (use Vapor side of PT chart)
- Pressure controls (cut in / cut out)
- Pressure related switches or controls – difference from R-502 pressures